

# CARVERaudio.com

A Website Devoted to the Legacy of Bob Carver's Electronics

This, and all manuals found on CARVERaudio.com have been painstakingly scanned, compiled, cataloged and archived by our [dedicated forum members](#), for the benefit of all Carver audio fanatics. These manuals are NOT intended for re-sale. If you should find these manuals "For Sale" on any website, please report your findings to us, so we may have them removed.

# CARVERaudio.com

# CARVER

***Powerful • Musical • Accurate***

SD/A-390t  
5-Disc Carousel CD Player  
with Linear Single-Bit D/A Converter

Owner's Manual

CARVER

# SD/A-390t

## 1. Safety Instructions

1. Read Instructions — All the safety and operation instructions should be read before the Carver Component is operated.

2. Retain Instructions — The safety and operating instructions should be kept for future reference.

3. Heed Warnings — All warnings on the Component and in these operating instructions should be followed.

4. Follow Instructions — All operating and other instructions should be followed.

5. Water and Moisture — The Component should not be used near water - for example, near a bathtub, washbowl, kitchen sink, laundry tub, in a wet basement, or near a swimming pool, etc.

6. Ventilation — The Component should be situated so that its location or position does not interfere with its proper ventilation. For example, the Component should not be situated on a bed, sofa, rug, or similar surface that may block any ventilation openings; or placed in a built-in installation such as a bookcase or cabinet that may impede the flow of air through ventilation openings.

7. Heat — The Component should be situated away from heat sources such as radiators, or other devices which produce heat.

8. Power Sources — The Component should be connected to a power supply only of the type described in these operation instructions or as marked on the Component.

9. Power Cord Protection — Power-supply cords should be routed so that they are not likely to be walked upon or pinched by items placed upon or against them, paying particular attention to cords at plugs, convenience receptacles, and the point where they exit the Component.

10. Cleaning — The Component should be cleaned only as recommended in this manual.

11. Non-use Periods— The power cord of the Component should be unplugged from the outlet when unused for a long period of time.

12. Object and Liquid Entry — Care should be taken so that objects do not fall into and liquids are not spilled into the inside of the Component.

13. Damage Requiring Service — The Component should be serviced only by qualified service personnel when:

- A. The power-supply cord or the plug has been damaged; or
- B. Objects have fallen, or liquid has spilled into the Component; or
- C. The Component has been exposed to rain; or
- D. The Component does not appear to operate normally or exhibits a marked change in performance; or
- E. The Component has been dropped, or its cabinet damaged.

14. Servicing — The user should not attempt to service the Component beyond those means described in this operating manual. All other servicing should be referred to qualified service personnel.



CAUTION



RISK OF ELECTRIC SHOCK  
DO NOT OPEN

**CAUTION: TO REDUCE THE RISK OF ELECTRIC SHOCK  
DO NOT REMOVE COVER (OR BACK)  
NO USER-SERVICEABLE PARTS INSIDE  
REFER SERVICING TO QUALIFIED SERVICE PERSONNEL**



The lightning flash with arrowhead symbol within an equilateral triangle is intended to alert the user to the presence of uninsulated "dangerous voltage" within the product's enclosure, that may be of sufficient magnitude to constitute a risk of electric shock to persons.



The exclamation point within an equilateral triangle is intended to alert the user of the presence of important operating and maintenance (servicing) instructions in the literature accompanying the appliance.

**PORTABLE CART WARNING**



Carts and stands - The Component should be used only with a cart or stand that is recommended by the manufacturer. A Component and cart combination should be moved with care. Quick stops, excessive force, and uneven surfaces may cause the Component and cart combination to overturn.

## SD/A-390t

15. To prevent electric shock, do not use this polarized plug with an extension cord, receptacle or other outlet unless the blades can be fully inserted to prevent blade exposure.

Pour prévenir les chocs électriques ne pas utiliser cette fiche polarisée avec un prolongateur, une prise de courant ou une autre sortie de courant, sauf si les lames peuvent être insérées à fond sans laisser aucune partie à découvert.

16. Grounding or Polarization — Precautions should be taken so that the grounding or polarization means of the Component is not defeated.

17. Internal/External Voltage Selectors — Internal or external line voltage selector switches, if any, should only be reset and re-equipped with a proper plug for alternate voltage by a qualified service technician. See an Authorized Carver Dealer for more information.

18. Attachment Plugs for Alternate Line Voltage (Dual voltage models only) — See your Authorized Carver Dealer for information on the attachment plug for alternate voltage use. This pertains to dual-voltage units only.

This apparatus does not exceed the Class A/Class B (whichever is applicable) limits for radio noise emissions from digital apparatus as set out in the radio interference regulations of the Canadian Department of Communications.

ATTENTION — Le présent appareil numérique n'émet pas de bruits radioélectriques dépassant les limites applicables aux appareils numériques de class A/de class B (selon le cas) prescrites dans le règlement sur le brouillage radioélectrique édicté par le ministère des communications du Canada.

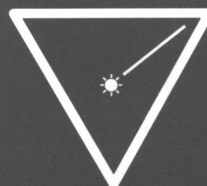

**CAUTION - HAZARDOUS LASER AND ELECTROMAGNETIC RADIATION WHEN OPEN AND INTERLOCK DEFEATED.**  
**ATTENTION - RAYONNEMENT LASER ET ELECTROMAGNETIQUE DANGEREUX SI OUVERT AVEC L'ENCLICHEMENT DE SECURITE ANNULÉ.**

**DANGER - Invisible laser radiation when open and interlock failed or defeated. AVOID DIRECT EXPOSURE TO BEAM.**

**WARNING – TO REDUCE THE RISK OF FIRE OR ELECTRIC SHOCK, DO NOT EXPOSE THIS APPLIANCE TO RAIN OR MOISTURE.**

**This Carousel Compact Disc Player is made and tested to meet exacting safety standards. It meets UL and FCC requirements and complies with safety performance standards of the U.S. Department of Health and Human Services.**

**CAUTION - USE OF CONTROLS OR ADJUSTMENTS OR PERFORMANCE OF PROCEDURES OTHER THAN THOSE SPECIFIED HEREIN MAY RESULT IN HAZARDOUS RADIATION EXPOSURE.**

**THE CAROUSEL COMPACT DISC PLAYER SHOULD NOT BE ADJUSTED OR REPAIRED BY ANYONE EXCEPT PROPERLY QUALIFIED SERVICE PERSONNEL.**

### FCC INFORMATION

This device complies with Part 15 of the FCC Rules. Operation is subject to the following two conditions: (1) this device may not cause harmful interference, and (2) this device must accept any interference received, including interference that may cause undesired operation.

Changes or modifications not expressly approved by the party responsible for compliance could void user's authority to operate the equipment.

**NOTE:** This equipment has been tested and found to comply with the limits for a Class B digital device, pursuant to Part 15 of the FCC Rules. These limits are designed to provide reasonable protection against harmful interference in a residential installation. This equipment generates, uses and can radiate radio frequency energy and, if not installed and used in accordance with the instructions, may cause harmful interference to radio communications. However, there is no guarantee that interference will not occur in a particular installation. If this equipment does cause harmful interference to radio or television reception, which can be determined by turning the equipment off and on, the user is encouraged to try to correct the interference by one or more of the following measures:

- Reorient or relocate the receiving antenna.
- Increase the separation between the equipment and receiver.
- Connect the equipment into an outlet on a circuit different from that to which the receiver is connected.
- Consult the dealer or an experienced radio/TV technician for help.

## SD/A-390t

### Contents

1. Safety Instructions .....	Page 2	Rear Panel Connections .....	8
2. A Message From Bob Carver .....	4	Connections - Conventional Hook-up ...	8
3. Features and Specifications .....	5	Connections - Digital Hook-up .....	9
4. Unpacking and Paperwork .....	6	System Configurations .....	9
5. Installation .....	6	6. Operation .....	10
Placement and General Considerations ...	6	Front Panel Features .....	10
Getting Started .....	7	Remote Control .....	15
Installing the Handles .....	7	7. About Soft EQ .....	20
Connection Tips .....	7	8. In Case of Difficulty .....	22
		9. Care and Service Assistance .....	23

## 2. A Message from Bob Carver

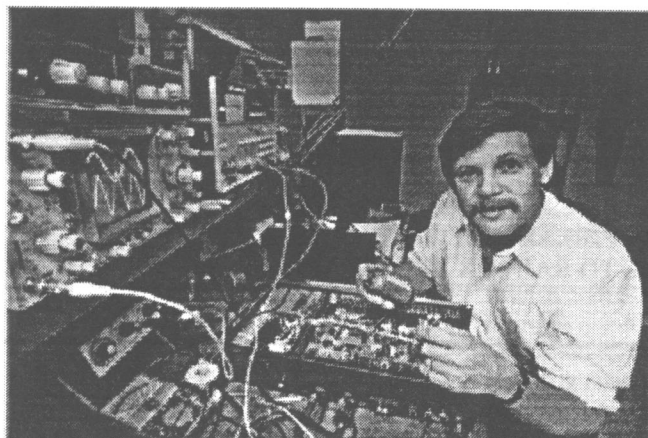

Congratulations on your purchase of a new Carver SD/A-390t Vacuum Tube Reference Multi Compact Disc Player. We expect that its sophisticated engineering and meticulous craftsmanship will provide you with many years of listening enjoyment.

The SD/A-390t is a 5-disc carousel CD player with Linear Single Bit D/A Conversion for increased sonic definition, detail and accuracy. You have chosen a "quality-first" CD player with triple-beam laser scanning, full remote control including volume control, random and repeat play.

For convenience in playing back CD's with different output levels, the SD/A-390t has a Level File, which memorizes the optimum volume level for each individual disc up to 100 discs.

In addition, a version of our Digital Time Lens circuit called "Soft EQ" sets the SD/A-390t apart from other CD players. "Soft EQ" is an extremely sophisticated circuit which prevents the loss of sonic front-to-back depth imaging, as well as the excessive brightness sometimes associated with compact disc recordings. How and when you use it depends on your choice of discs, your type of speakers, and your own musical taste.

The SD/A-390t features two 6DJ8 vacuum tubes in the final output stage. They achieve very low static and transient distortion while providing extremely high dynamic headroom. This simple but elegant output stage results in unparalleled transparency. Because the tubes are run at less than 25% of their maximum capacity, they are not susceptible to "aging" effects and should last the lifetime of the SD/A-390t without replacement.

Your SD/A-390t compact disc player was designed by people with a lifetime commitment to providing the world's finest components for music reproduction and home entertainment. Thanks for placing your confidence in Carver, and we hope your new CD player will provide many years of listening enjoyment.

Very truly yours,

Bob Carver  
Chairman

## SD/A-390t

### 3. Features and Specifications

#### SD/A-390t Special Features

- Linear single-bit D/A converters
- 8 times oversampling with noise shaping high precision digital filters
- 3 beam laser pickup
- Full function remote control
- 5 disc carousel
- Allows user to change up to 4 discs without interrupting play
- Accepts 3" and 5" discs
- Direct track selection
- Multi-disc programming plays up to 20 tracks from any of the 5 discs.
- 5 repeat modes
- 3 random play modes
- Coaxial digital output allows use of outboard converter
- Dual 6DJ8 vacuum tube analog output stage
- Fixed and variable outputs
- Remote volume control
- Headphone jack
- 100 disc volume level memory
- Carver's exclusive Soft EQ circuit to enhance tonal balance and spatial ambience of CDs

#### Specifications

**Frequency Response:**

20Hz to 20kHz ( $\pm 0.5$  dB), Soft EQ off

**Signal-to-Noise Ratio:**

More than 95 dB

**Total Harmonic Distortion:**

$\leq 0.15\%$  at 1kHz, 0dB

**Wow and Flutter:**

Unmeasurable

**D/A Conversion:**

1 bit MASH

**Dynamic Range:**

94 dB

**Line Output Level at 0dB**

**Fixed:** 1.6V rms ( $\pm 1$  dB),  
into 100 kilohms

**Variable:** 0-1.6V rms ( $\pm 1$  dB),  
into 100 kilohms

**Output Impedance:**

750 ohms

**Maximum Headphone Output:**

1.5V rms into 60 ohms (37.5 mW)

2.7V rms into 600 ohms (12 mW)

**Laser:**

3-beam, 790 nm

**Power Consumption:**

15W

**Power Requirements:**

120VAC/60Hz (USA and Canada)

Other voltages as required for export

**Size (H x W x D):**

4.75" x 17" (19" with handles) x 16"

121mm x 432mm (483mm w/handles) x 406mm

**Net Weight:** 14.9 lbs. (6.8 kgs)

**Shipping Weight:** 18.1 lbs. (8.2 kgs)

**Accessories:**

RH-39 Handheld Remote Control, Two AA batteries, One pair connecting cords.

Features and specifications are subject to change without notice.

## SD/A-390t

### 4. Unpacking and Paperwork

Carefully unpack your SD/A-390t and keep the original carton and packing materials for future moving, shipment or long-term storage.

After opening the box, please check for any visible signs of damage that were not apparent from the outside of the box. If you do encounter what appears to be concealed damage, please consult your Carver Dealer before proceeding to further unpack or install the unit.

#### Important Paperwork

Make sure to save your sales receipt. Your receipt is extremely important to establish the duration of your Limited Warranty, and for insurance purposes. Next, make a note of the serial number which is located on the back of the SD/A-390t. Record it in the space provided below for convenient reference.

Model: **SD/A-390t**

Serial Number: \_\_\_\_\_

Purchased at: \_\_\_\_\_

Date: \_\_\_\_\_

Finally, take a moment to fill out and return the Warranty Card packed with the SD/A-390t and return it to Carver. This provides us with important information about you, our valued customer.

### 5. Installation

#### Placement and General Precautions

Observe the following precautions when choosing a location for the SD/A-390t:

- Do not expose the unit to rain or moisture.  
If a fluid or foreign object should enter the unit, disconnect the power plug and contact an authorized dealer or service center. Do not pull out the plug by pulling on the cord; grasp the plug firmly.
- Protect from prolonged exposure to direct sunlight.
- Avoid excessive exposure to extreme cold or dust. If the SD/A-390t is cold and brought into a warm room, condensation may form on the laser mechanism and prevent normal operation. Wait at least 30 minutes to allow the unit to warm to room temperature before playing.
- Avoid exposure to electrostatic discharge.
- Do not place heavy objects on the unit.
- Protect from heat and allow adequate ventilation. Place away from direct sources of heat, such as heating vents and radiators. Avoid placing on top of a power amplifier.

All components produce some heat during operation, particularly the output tubes, so make sure that ventilation holes are not covered, and that air is allowed to circulate freely behind, beside and above the unit. Excessive heat is the single greatest source of both short-term and long-term component failure.

## SD/A-390t

- Do not place the SD/A-390t directly next to, or on top of a receiver or FM/AM tuner. The SD/A-390t contains a microcomputer to control all of its functions. To prevent possible interference when listening to AM or FM while the SD/A-390t is turned on, we suggest that your new CD player be positioned at least one component away from a tuner or receiver when stacking or placing your equipment in a row or on a shelf. (See *FCC Information* on page 3.)
- Avoid placing the SD/A-390t next to or on top of a television set, cable converter box or video cassette recorder.
- Avoid placing the SD/A-390t where it will receive heavy vibration, such as on top of a large speaker or subwoofer. While the SD/A-390t is acoustically isolated against most physical shocks, it WILL skip if jarred too violently.

### Getting Started

No special tools are required to make connections to the SD/A-390t. Simply use the supplied interconnect cable between the **FIXED** or **VARIABLE OUTPUT** jacks on the back of the SD/A-390t and the CD input jacks on your preamplifier or receiver. See *Connection Tips* next for information on connecting the **DIGITAL OUTPUT** jack.

If installing in a cabinet, provide sufficient cable slack to allow turning the CD player around 90° to make all connections. If this is not possible, a small lamp and hand mirror may be helpful in making some connections.

### Installing the Handles

The optional front panel handles are easily installed by removing the two screws located on each side of the front panel with a Phillips screwdriver. Line up the holes in the sides of the front panel with the holes in the handle brackets and reinstall the screws through the brackets into the front panel.

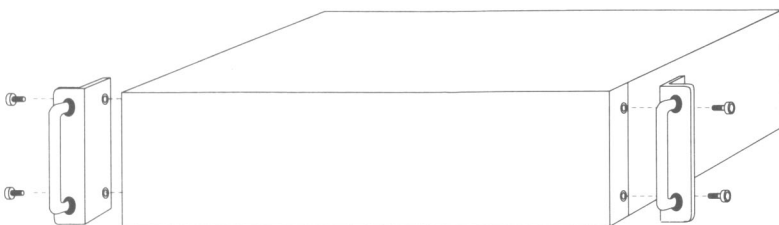

### Connection Tips

Please consider the following tips when connecting the unit to your stereo system:

- Make sure all components are **OFF** before making any connections. It's a good idea to plug in your AC power cord last to avoid accidentally turning on the unit while installing.
- Make sure that "left is hooked to left and right is hooked to right" at each connection. The obvious way to assure this is to assign one hook-up cord plug color to left and the other to right. Generally **RED** is used to signify **RIGHT**. White, grey or black then represents left.
- Whenever possible, keep power cords away from signal cables (inputs from CD player, tape deck, etc.) to prevent hum. While hum is less of a problem today than it was in the past, noise can still find its way into your system if a component's power cord becomes too intimately involved with a hook-up cable. Carver components' power cords and convenience outlets are all on the right side of the chassis (when viewed from the back). This allows you to bundle all the component power cords and keep them separate from signal connections.
- Type of hook-up cables. Also called interconnects, patch cords or RCA cables. There are lots of different grades of hook-up cables. You can pay more than \$50 per foot for some of them! Whether or not you hear an improvement in sound quality with "audiophile" interconnects is up to your own ears. However, really **CHEAP** or old connection cables can sometimes **DIS**-connect themselves inside, causing hum or a loss of sound in one or both channels. Before you send a component in for service, swap hook-up cables to see if they're the culprit.

**Warning:** Never plug the SD/A-390t into a receiver or preamplifier's **PHONO** inputs, either moving coil (MC) or moving magnet (MM).



# SD/A-390t

## Rear Panel Connections

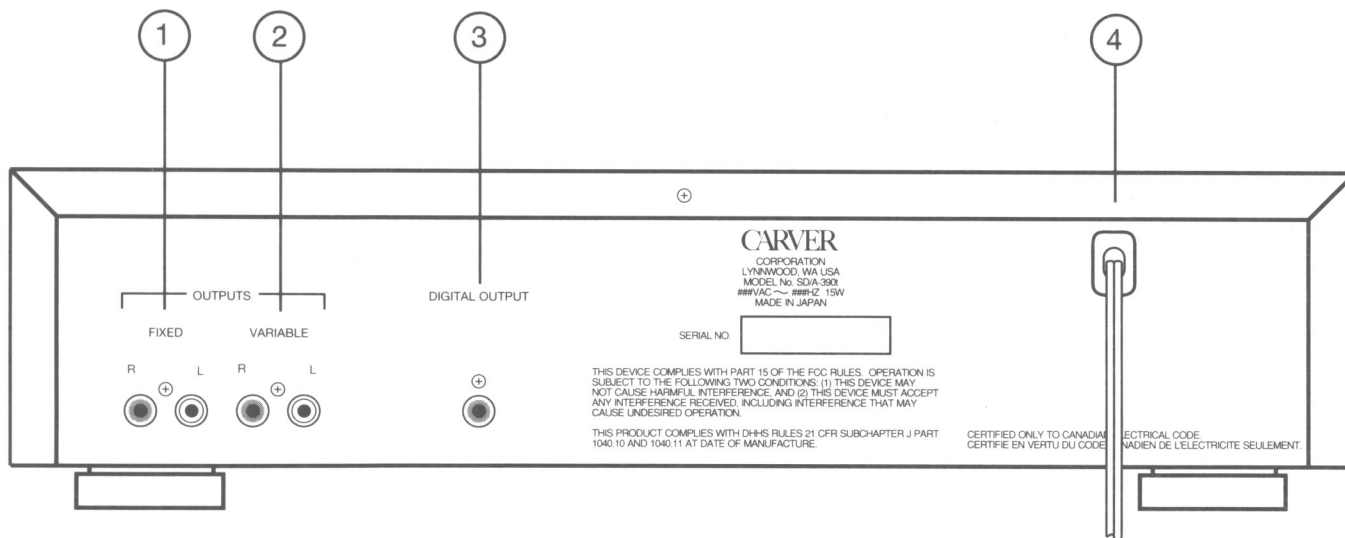

### 1. FIXED OUTPUT jacks

Connect to the CD input jacks on your preamplifier or receiver. The volume level at the FIXED OUTPUTS remains constant regardless of the volume adjustment on the remote control.

### 2. VARIABLE OUTPUT jacks

Connect to the CD input jacks on your preamplifier or receiver. The volume level at the VARIABLE OUTPUTS can be changed by adjusting the VOLUME UP/DOWN control on the remote control.

### 3. DIGITAL OUTPUT jack

Connect to the DIGITAL INPUT jack on your outboard D/A converter or preamplifier/receiver with its own internal D/A converter.

### 4. AC LINECORD

Connect to an outlet properly configured for the line voltage specified for your model. If using an extension cord, we recommend 16 gauge or heavier.

## Connections — Conventional Hook-up

There are two sets of line level outputs on the back of the SD/A-390t: FIXED and VARIABLE. The vacuum tube stage in the SD/A-390t serves both of these outputs. In either case, follow these

steps to connect your SD/A-390t to the rest of your system.

1. Make sure that the SD/A-390t and the rest of your stereo system are turned off or disconnected.
2. Locate the FIXED and VARIABLE OUTPUT jacks on the SD/A-390t's rear panel.
3. Connect one end of a RED connection cable (patch cord) plug to the RIGHT (R) output jack on either pair of line outputs on the SD/A-390t.
4. Connect the corresponding WHITE connection cable plug to the SD/A-390t's LEFT (L) output jack.
5. You're now ready to attach the other end of the connection cable to something. Depending on what kind of receiver or preamplifier you have, there may be several options.
  - A. Use the CD INPUTS that are provided on newer preamplifiers and receivers.
  - B. Hook the SD/A-390t to the receiver/preamp's AUX inputs.
  - C. If options A or B are unavailable, use one of the receiver/preamp's TAPE INPUTS or,
  - D. Hook the SD/A-390t VARIABLE OUTPUTS directly to the inputs of your power amplifier.

# SD/A-390t

- When you have made your choice, plug the free end of the RED connection cable into the receiver/preamp's RIGHT INPUT jack and plug the free end of the WHITE connection cable into the LEFT INPUT jack.
- Connect the SD/A-390t's power cord to an AC outlet. This can be a wall socket, an extension cord or a switched/unswitched outlet on the back of a receiver or preamplifier.

## Connections — Digital Hook-up

If you have a separate D/A converter or a preamplifier or receiver which has its own coaxial DIGITAL INPUT JACK and internal D/A converter, you can bypass the SD/A-390t's own digital-to-analog and analog output circuitry entirely.

## Circuitry bypassed by DIGITAL OUTPUT

**Note:** The SD/A-390t's VOLUME control, Soft EQ and tube circuits have no effect when you use the DIGITAL OUTPUT jack.

- Make sure that the SD/A-390t and the rest of your stereo system are turned off or disconnected.
- Locate the single DIGITAL OUTPUT jack on the SD/A-390t's rear panel.
- Connect one end of a connection cable plug to the DIGITAL OUTPUT jack on the SD/A-390t.
- Connect the other end to the DIGITAL INPUT jack on your outboard D/A converter or preamplifier with built-in D/A converter.
- Connect the SD/A-390t's power cord to an AC outlet. This can be a wall socket, an extension cord or a switched/unswitched outlet on the back of a receiver or preamplifier.

## SYSTEM CONFIGURATIONS

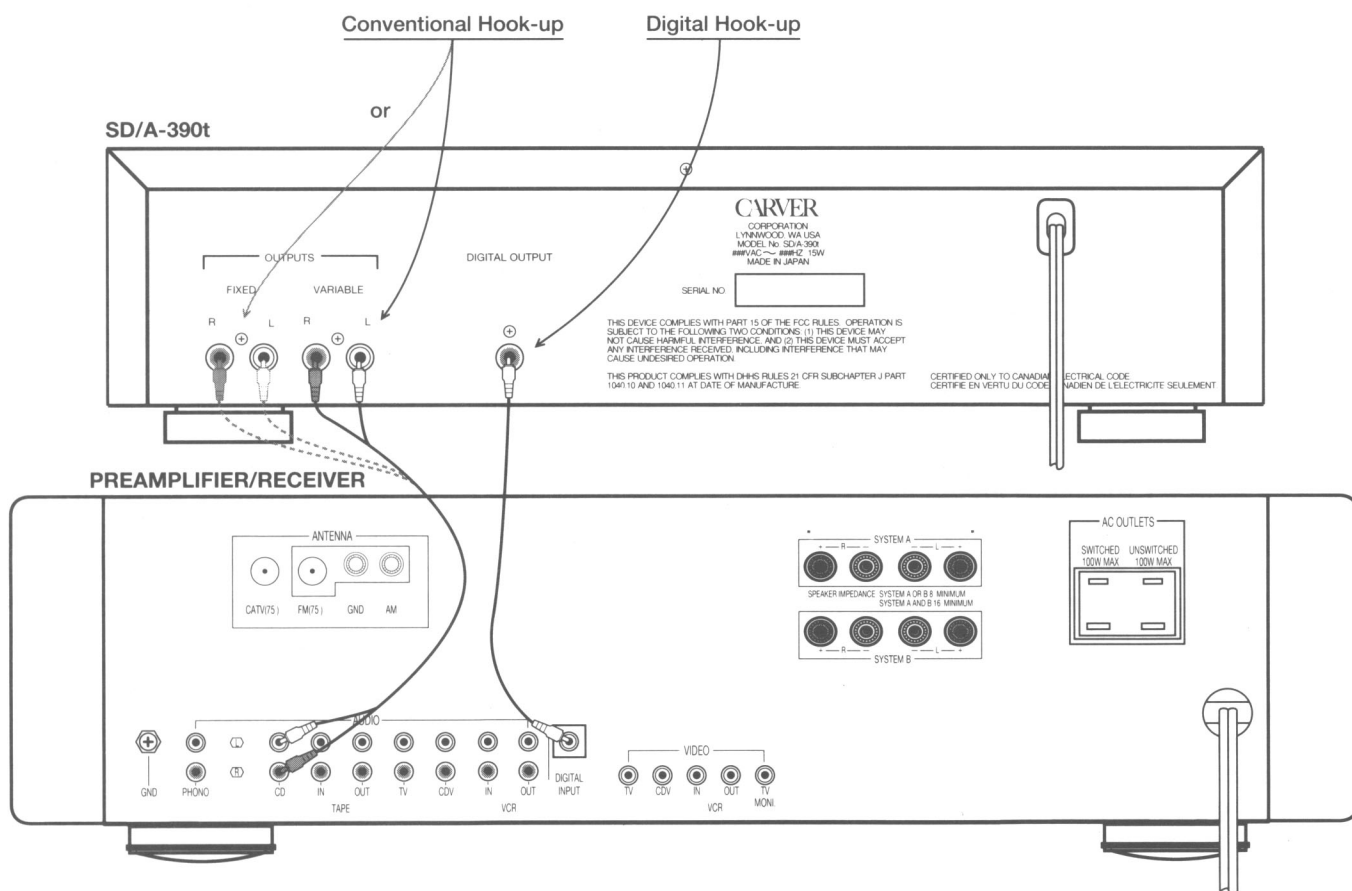

## SD/A-390t

# Operation

### Front Panel Features

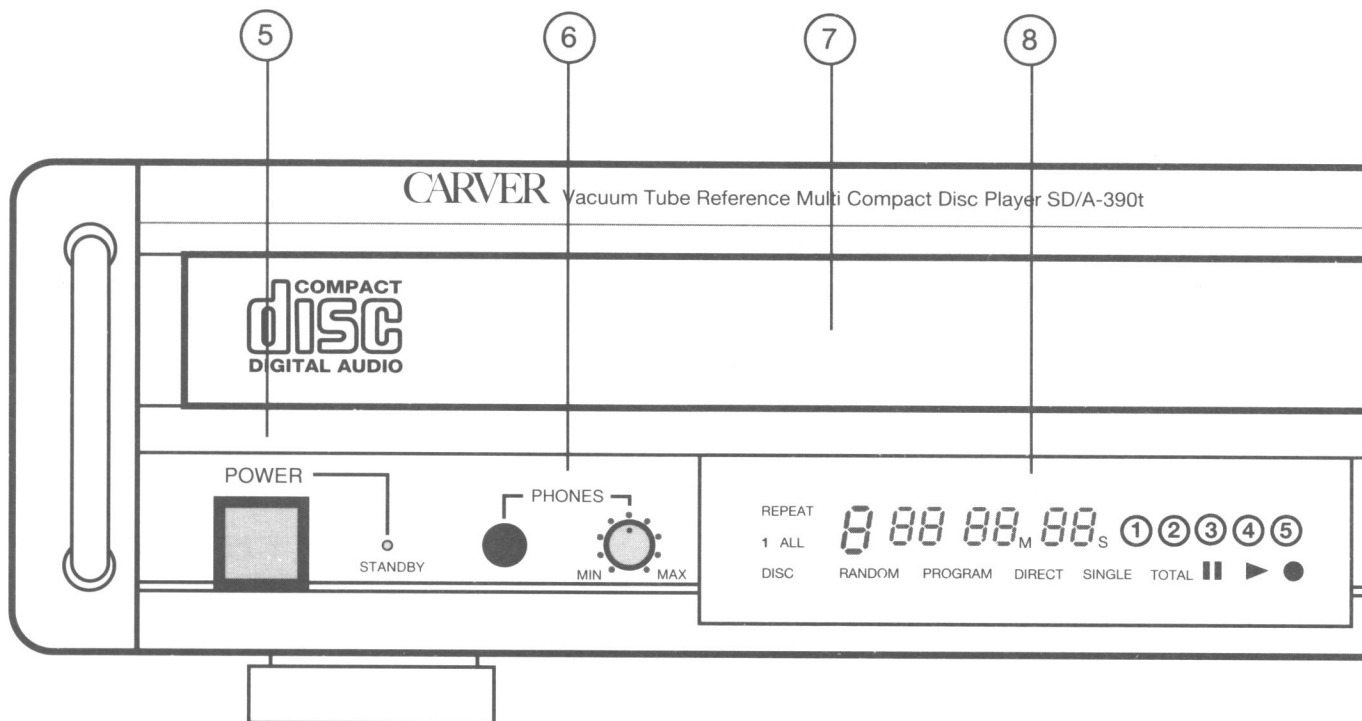

#### 5. POWER switch and STANDBY indicator

When this switch is pressed in, the power turns ON and indicators appear in the display panel. The STANDBY LED will flash for about 30 seconds to indicate that you should wait for the tubes to warm up to their optimum operating temperature before beginning playback. When the STANDBY LED lights continuously, you may begin play.

If the POWER switch is pressed again, the power to the unit is turned off and the STANDBY LED goes off.

⚠ **Note:** The remote sensor is temporarily disabled while the STANDBY LED flashes. The remote control can be used after the STANDBY LED lights continuously. Also discs can be loaded or unloaded while the STANDBY LED is flashing.

#### 6. PHONES

All conventional dynamic headphones may be plugged in here. Headphone impedance may range from a few ohms to several thousand ohms, although output level will vary depending on the impedance. Adjust the headphone volume control to obtain the volume level most comfortable for your particular headphones.

⚠ **Note:** The PHONES output comes after the Soft EQ circuit and the output tubes, but is not affected by the VOLUME control on the remote control unit.

# SD/A-390t

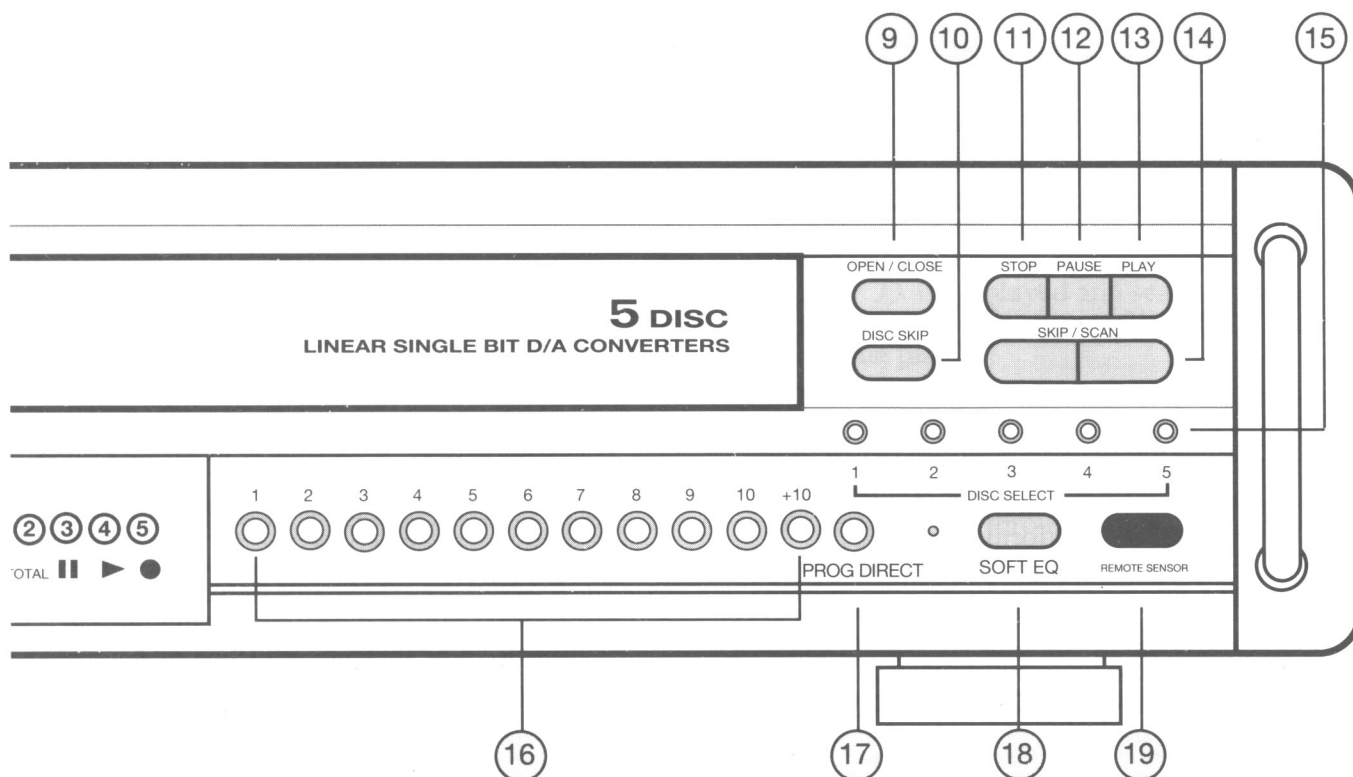

## 7. DISC TRAY

This is where the compact discs are placed. Pressing the OPEN/CLOSE button will cause the tray to move out like a drawer. There are five recessed compartments in the tray, four of which are accessible for loading and unloading discs. Place the discs label side up in the compartments. Push the DISC SKIP button to rotate the compartments in the tray so that you can access the fifth compartment.

**Note:** The DISC TRAY can be opened while a disc is playing, and the disc will continue to play. This allows you to change CDs in any of the other four compartments without interrupting the music. The DISC SKIP button is deactivated while a disc is playing and the disc tray is in the out position.

**CAUTION:** Do not try to insert a disc into the compartment towards the very back of the tray while a disc is playing. This is where the disc is located, and you could damage the playback mechanism.

Do not try to push the tray closed by hand when the SD/A-390t is switched off. Always use the OPEN/CLOSE button to advance or retract the tray.

Do not place any foreign objects in the tray, and do not place more than one disc in a compartment at a time.

Do not touch the carousel while it is turning, or attempt to stop it by hand. Do not attempt to rotate the carousel by hand at any time. Always use the DISC SKIP button to rotate the carousel.

If your finger should get caught in the tray while closing, press the OPEN/CLOSE button.

**REMOVE ALL DISCS** from the SD/A-390t before attempting to move the player.

## SD/A-390t

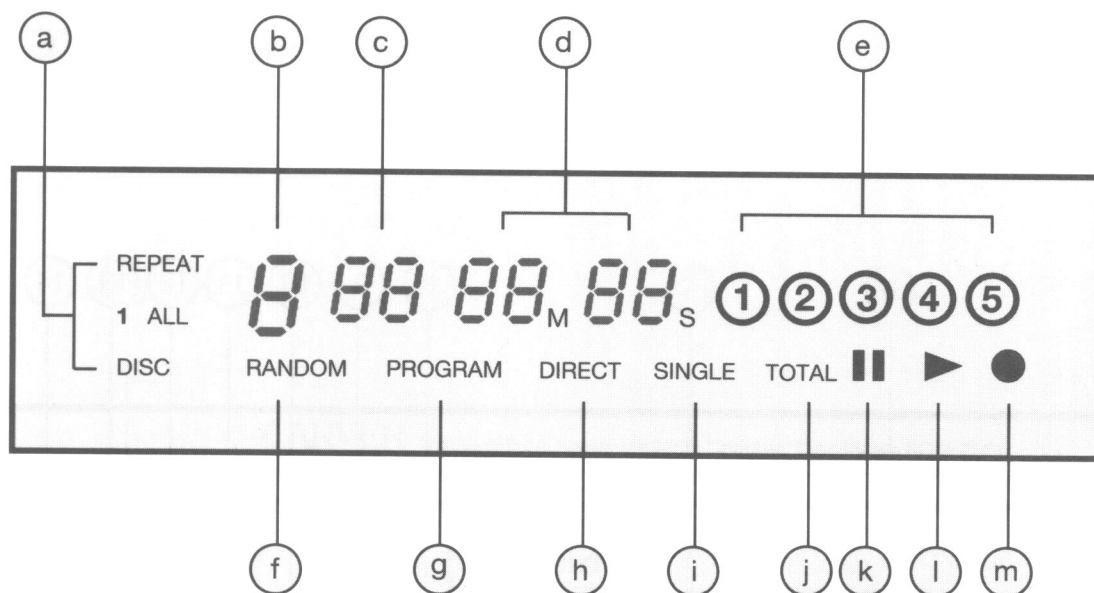

### 8. DISPLAY

This fluorescent display helps you keep track of the SD/A-390t's various functions including which track is currently playing, programming, elapsed time and other information such as Random and Repeat modes.

a. "REPEAT 1" will light when the REPEAT button is pressed on the remote control, indicating that the currently playing track will repeat. "REPEAT 1 DISC" will light when the REPEAT button is pressed again indicating that the currently playing disc will repeat. "REPEAT ALL DISC" will light when the REPEAT button is pressed a third time indicating that all the discs in the carousel will repeat in order.

b. Disc Number – Indicates which disc is currently playing or ready to play.

c. Track Number – During playback, this indicates which track is currently playing. During STOP mode, this indicates the total number of tracks on the disc. When STOP is pressed while in Program mode, the first track of the programmed sequence is displayed here.

d. Minutes (M) and Seconds (S) – During playback, this indicates the number of minutes and seconds elapsed or remaining. During STOP mode, it indicates the total number of minutes and seconds on the disc.

When STOP is pressed while in Program mode, "– – M – – S" is displayed here (except when all the selections programmed are from one disc, and only the track numbers are entered – not the disc number – TOTAL time remaining for the program will be displayed.

e. ①②③④⑤ – Normally lit. If an empty disc compartment is detected during DISC SKIP or DISC SELECT, the corresponding disc number will go out.

f. RANDOM – This will light when the RANDOM button is pressed on the remote control to indicate Random Play mode.

g. PROGRAM – This will light when the PROG/DIRECT button is pressed on the front panel or the PROGRAM button is pressed on the remote control, to indicate Program Play mode.

h. DIRECT – This will light when the SD/A-390t is first turned on, indicating Direct Play mode.

i. SINGLE – This will light when the TIME button on the remote control is used to display the time remaining on the currently playing track.

j. TOTAL – This will light when the TIME button on the remote control is used to display the time remaining on the currently playing disc.

k. II – This will light when the PAUSE button is pressed.

l. ▶ – This will light when the PLAY button is pressed.

m. ● – This will blink whenever an infrared command is received from the remote control unit to indicate that the SD/A-390t has recognized the command.

## SD/A-390t

### 9. OPEN/CLOSE

Press this button to open or close the DISC TRAY. If the tray is in the open position and no disc is playing, pressing PLAY will cause the tray to close and playback to begin on the first available disc.

### 10. DISC SKIP

Each time this button is pressed, the carousel in the tray will rotate clockwise one position. When the tray is open, this can be used to load or replace discs (except during playback). When the tray is closed, it can be used to select the next disc for play.

**Note:** The DISC SKIP button will not operate when the tray is open and a disc is being played, or during FULL RANDOM PLAY or PROGRAM PLAY mode.

### 11. STOP

Press this button to stop playback. The laser pickup is reset back to its original starting position and waits for the next PLAY command.

### 12. PAUSE

Press this button to stop playback temporarily. The ► indicator goes off and the || indicator lights in the display. This causes the laser pickup to remain at the point where the PAUSE command was executed, ready to resume playback at that point. To resume playback, press the PAUSE button again or press the PLAY button.

### 13. PLAY

Press this button to begin playback of a disc. The ► indicator lights up in the display. The disc number, track number and the elapsed time for the current track are also displayed.

The ► indicator goes off at the end of the disc, or when the STOP or PAUSE buttons are pressed.

### 14. SKIP/SCAN

Pressing these buttons quickly will cause the laser pickup to skip to previous or subsequent tracks on the disc. Pressing the left hand button once will cause the pickup to move to the beginning of the current track. Press it again to move

to previous tracks. Pressing the right hand button will cause the pickup to move to the next track.

Pressing the button continuously for more than 1/2 second will cause a fast search during playback. When SCAN is activated, you will hear a sped-up version of the music.

Pressing the left hand button will cause a reverse scan in the track being played. If reverse SCAN causes the pickup to reach the beginning of the disc, ⌂ is displayed and scanning stops. Press and release the forward SKIP/SCAN button to continue play.

Pressing the right hand button will cause a forward scan in the track being played. If forward SCAN causes the pickup to reach the end of the disc, ⌂ is displayed and scanning stops. Press and release the reverse SKIP/SCAN button to continue play.

The SCAN mode can also be used when the PAUSE mode is activated. No sound is heard while the PAUSE mode is active, but pressing the SCAN buttons will move the laser pickup forward or backward through the track at a rate three times faster than in normal SCAN mode. This can be used to quickly cue up a point for playback.

### 15. DISC SELECT Buttons

These buttons allow you to directly select any one of the five discs for playback. Simply push the button for the disc you want to play. The carousel will rotate to the disc you have selected and playback will start at the beginning of the disc.

### 16. Track Select Buttons

These buttons allow you to directly select any track on the disc for playback. For track numbers between 10 and 20, push the +10 button followed by a 1-9 button. For example, to select track 15, press the +10 button followed by the 5 button. For track numbers between 20 and 30, press the +10 button twice followed by a 1-9 button.

Pressing these buttons during playback will cause the laser pickup to move to the selected track and begin playing it immediately. Pressing these buttons during PAUSE mode, will cause the laser pickup to move to the selected track and wait until either the PAUSE button is pressed again or the PLAY button is pressed.

# SD/A-390t

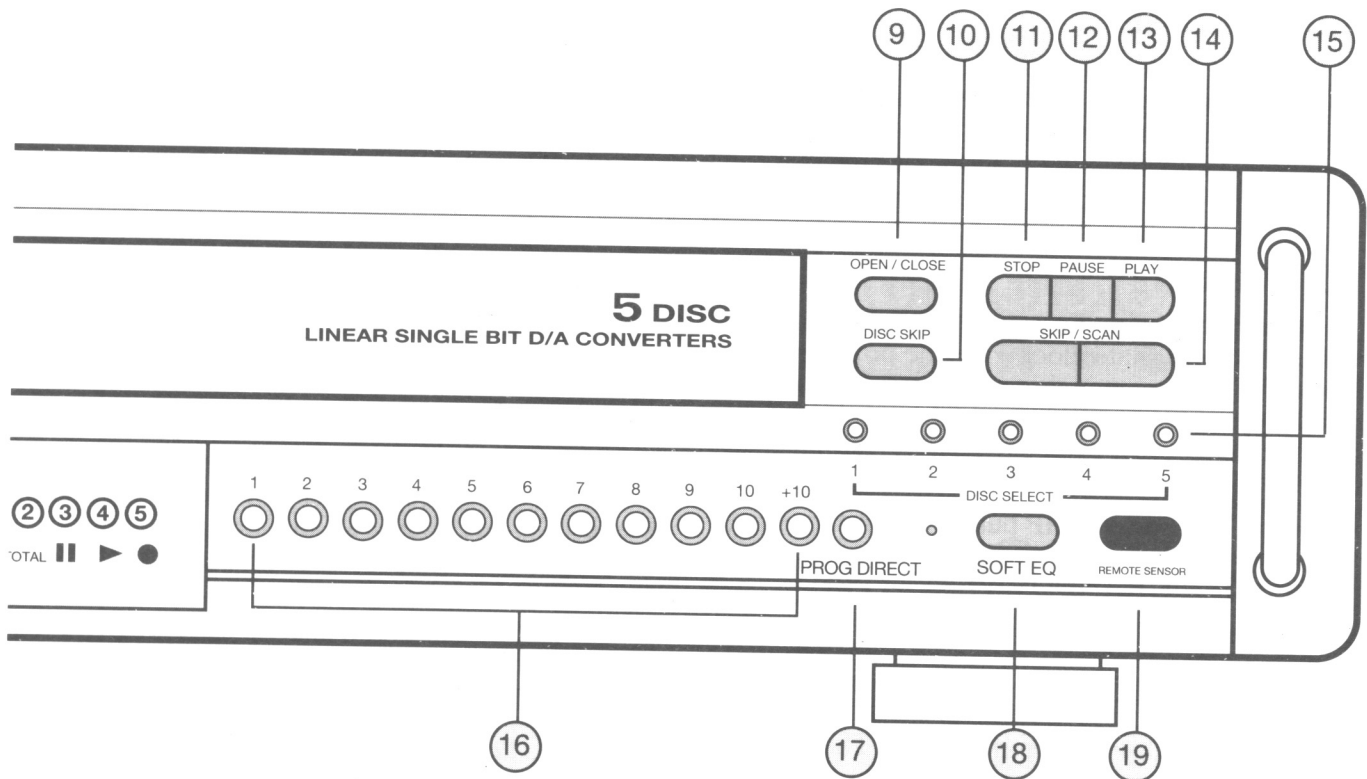

## 17. PROG/DIRECT

Pressing this button places the SD/A-390t into Programming Mode, and PROGRAM lights up in the display. Up to 20 tracks from any of the five discs can be programmed for playback.

To program tracks:

1. In STOP mode, press the PROG/DIRECT button. PROGRAM will light in the display.
2. Press the disc number in the DISC SELECT buttons to choose the disc.
3. Press the track number in the TRACK SELECT buttons to choose the specific track you want to program.
4. The SD/A-390t has now stored that disc and track number in its memory.
5. If the next track you wish to program is on the same disc as the previous track, simply select the new track number. It is not necessary to press the DISC SELECT button again.

If the next track is on a different disc, press the DISC SELECT button for the new disc and then select the track number.

6. If you wish to play all the tracks on a disc, just push the DISC SELECT button for that disc. Don't specify any track numbers, and the disc will play back in its entirety.

For example, if you want to play track 5 on disc 1, track 8 on disc 1, all of disc 3, and track 12 on disc 4:

- a) Press PROG/DIRECT.
  - b) Press DISC SELECT 1.
  - c) Press TRACK SELECT 5.
  - d) Press TRACK SELECT 8.
  - e) Press DISC SELECT 3.
  - f) Press DISC SELECT 4.
  - g) Press TRACK SELECT 12.
  7. When you have completed programming, press the PLAY button to begin playing back the tracks in the order you have programmed them.
- Note:** You can add more tracks to the Program at any time by repeating steps 2 and 3.

## SD/A-390t

During programmed play, you can use the SKIP/SCAN buttons. The SD/A-390t will skip through the programmed tracks in the sequence you have programmed them.

When using SCAN during programmed play, you can SCAN to an adjacent track on the disc even though it hasn't been programmed for playback. When the pickup reaches the end of the track, it will move to the next programmed track.

You can check the contents of the programmed memory by pressing the CALL button on the remote control. Each press of the CALL button will increment the disc and track numbers in the display through the programmed sequence. The Program Number is displayed in the "Seconds" position.

Pressing the PROG/DIRECT button again will cancel the program, erase it from memory and put the SD/A-390t back into Direct Play Mode. Playback will continue from the point at which the program was canceled until the end of the disc and stop.

Pressing the OPEN/CLOSE button will also erase the program from memory.

### 18. SOFT EQ

Pressing this button activates the SD/A-390t's special EQ/ambience circuit and illuminates the indicating LED just to the left of the button. Pressing it again turns the Soft EQ circuit off. See *About Soft EQ* on page 20 for more information about this unique Carver circuit.

### 19. REMOTE SENSOR

This window receives infrared signals from the remote control unit. Aim the remote control at this sensor for proper signal transmission.

## Remote Control

### RH-39 Handheld Remote Transmitter

#### Batteries

The RH-39 wireless infrared remote requires two AA batteries. Remove the battery compartment door on the back of the remote control by pressing in at the indented side of the door and lifting up. Insert the batteries supplied, making sure to match the positive (+) and negative (-) ends with the diagram inside the battery compartment.

#### Remote Operation

The remote control unit will work in a range of approximately 20 feet in front of and about 30 degrees to either side of the SD/A-390t.

If the remote control begins to occasionally not respond, 1) check its batteries; 2) make sure the infrared projection area on its tip is clean; 3) check that the SD/A-390t infrared remote sensor window is not dirty or blocked from direct line-of-sight with the remote.

**Note:** Intense sunlight contains some infrared light which can interfere with the transmission of the infrared signals from the remote control. Avoid placing the SD/A-390t in a position where it will be exposed to bright or direct sunlight.

If you choose not to use the SD/A-390t's remote, be sure to remove the batteries to prevent corrosion damage from leaking batteries.

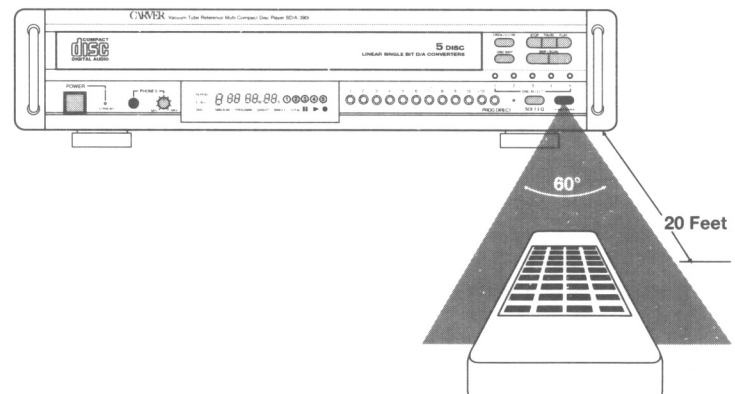



## SD/A-390t

Many of the remote control's functions are duplicates of the SD/A-390t front panel functions. These are indicated by black circles with white numbers on the remote control diagram. Functions that are unique to the remote control are indicated by white circles with black letters.

### 13. PLAY

Press this button to begin playback of a disc. The ► indicator lights up in the display. The disc number, track number and the elapsed time for the current track are also displayed.

### 12. PAUSE

Press this button to stop playback temporarily. The ► indicator goes off and the || indicator lights in the display. This causes the laser pickup to remain at the point where the PAUSE command was executed, ready to resume playback at that point. To resume playback, press the PAUSE button again or press the PLAY button.

### 11. STOP

Press this button to stop playback. The laser pickup is reset back to its original starting position and waits for the next PLAY command.

### 9. OPEN/CLOSE

Press this button to open or close the DISC TRAY.

### 20. TRACK SKIP ◀◀ ▶▶

Pressing these buttons will cause the laser pickup to skip to previous or subsequent tracks on the disc. Pressing the left hand button (◀◀) will cause the pickup to move to the beginning of the current track while in PLAY mode (or to the previous track in STOP mode). Press it again to move to previous tracks. Pressing the right hand button (▶▶) will cause the pickup to move to the next track.

### 21. SCAN ◀▶

Pressing these buttons will cause a fast search during playback. When SCAN is activated, you will hear a sped-up version of the music.

Pressing the left hand button (◀◀) will cause a reverse scan in the track being played. Pressing the right hand button (▶▶) will cause a forward scan in the track being played.

The SCAN mode can also be used when the PAUSE mode is activated. No sound is heard while the PAUSE mode is active, but pressing the SCAN buttons will move the laser pickup forward or backward through the track at a rate three times faster than in normal SCAN mode. This can be used to quickly cue up a point for playback.

### 22. RANDOM Play

This button is unique to the remote control. There are three ways in which the RANDOM play mode can be used.

1) FULL RANDOM PLAY – In this mode of operation, the SD/A-390t's microcomputer will choose discs and tracks at random from all five discs. If less than five discs are loaded, the SD/A-390t will sense there is no disc present the first time the random mode chooses an empty disc space and delete its number from the display.

Press the RANDOM button and then press the PLAY button to begin Full Random Play.

2) PROGRAM RANDOM PLAY – In this mode of operation, you can first program a sequence of discs and tracks into the SD/A-390t's memory, and then play that program back randomly.

To begin Program Random Play, press the PROG/DIRECT button on the front panel or the PROGRAM button on the remote control, and follow the instructions for programming a sequence of tracks given on page 14. When the programming is completed, press the RANDOM button and then press the PLAY button.

3) DISC SEQUENTIAL RANDOM PLAY – In this mode of operation, you can have each disc play back randomly in its entirety before moving on to the next disc. Furthermore, the order of the discs can be specified. Up to five discs can be selected, and the same disc can be selected more than once.

To begin Disc Sequential Random Play, press the RANDOM button, and then press the DISC SELECT numbers in the desired order. Then press the PLAY button. The microcomputer will

# SD/A-390t

select the tracks from the specified discs at random, in the order in which the discs were selected.

To cancel RANDOM play, press the RANDOM button once again. RANDOM will disappear from the display. Pressing the OPEN/CLOSE button will also cancel RANDOM play.

**Note:** RANDOM play can be initiated during playback at any time by pressing the RANDOM button.

If SCAN is used during RANDOM play, scanning to the beginning or the end of a track will cause the SD/A-390t to randomly select a new track.

## 23. REPEAT

This button is unique to the remote control. There are five ways in which the REPEAT mode can be used.

1) REPEAT 1 TRACK – In this mode of operation, a track currently being played will be repeated. Simply press the REPEAT button once and REPEAT 1 will appear in the display.

**Note:** You can use SCAN to move to an adjacent track and that track will be repeated.

2) REPEAT DISC – In this mode of operation, a disc currently being played will be repeated. Press the REPEAT button again (second time) and REPEAT 1 DISC will appear in the display.

3) REPEAT ALL – In this mode of operation, all the discs currently loaded in the SD/A-390t will be repeated sequentially. Press the REPEAT button again (third time) and REPEAT ALL DISC will appear in the display.

To cancel REPEAT play, press the REPEAT button one more time (fourth time). REPEAT will disappear from the display. Pressing the OPEN/CLOSE button will also cancel REPEAT play.

4) REPEAT PROGRAM PLAY – Pressing the REPEAT button while a program is being played will cause the entire program to repeat itself. REPEAT ALL DISC will be displayed.

5) REPEAT RANDOM PLAY – Pressing the REPEAT button while in RANDOM play will cause the RANDOM play mode to continue indefinitely. REPEAT ALL DISC will be displayed.

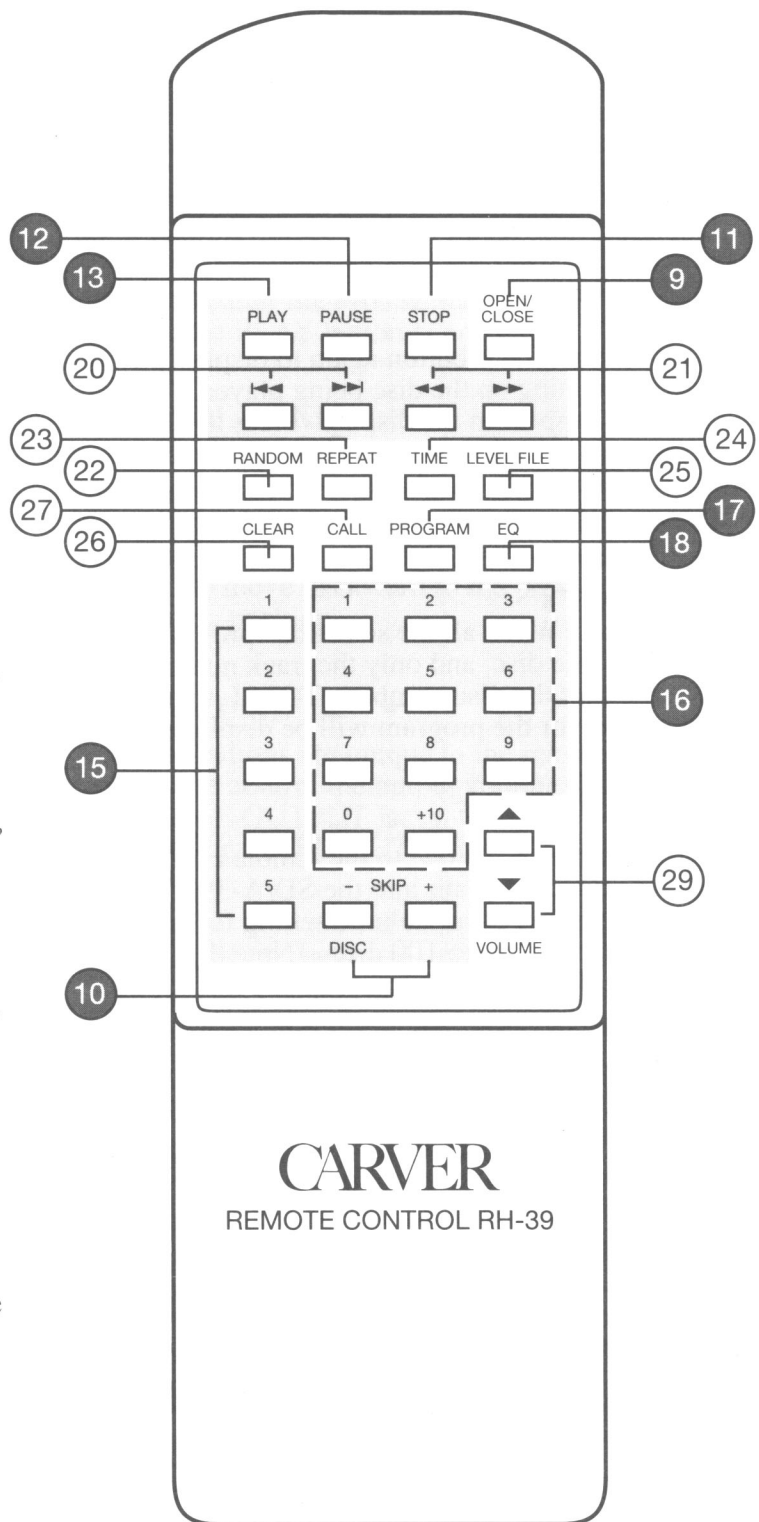

SD/A-390t Remote Control

## SD/A-390t

### 24. TIME

This button is unique to the remote control. It allows you to change the display to indicate either elapsed time of the current track being played, time remaining on current track being played, and time remaining on the disc being played.

Normally, the display will show the elapsed time of the current track being played. Press the TIME button once to display the time remaining on the current track. SINGLE will appear in the display.

Press the TIME button again to display the time remaining on the disc being played. TOTAL will appear in the display. Press the TIME button again to return to the elapsed time of the current track.

While in PROGRAM Play or RANDOM Play, the display for the TOTAL time remaining will be “--M--S”.

*Exception:* When all the selections programmed are from one disc, and only the track numbers are entered (not the disc number), TOTAL time remaining for the program will be displayed.

### 25. LEVEL FILE

This button is unique to the remote control. It allows you to program into the SD/A-390t's memory the optimum volume setting for each individual disc, up to 100 discs. Note that this only affects the variable output.

To Store a Level:

1. Begin playback of the disc whose volume level you wish to program into memory.
2. Set the Volume control on your preamplifier or receiver to the position you normally use for listening.
3. Use the VOLUME UP/DOWN buttons on the remote control to set the volume level of the CD to the optimum listening level. You will probably want the volume to match that of your other source components such as your tuner, tape deck and VCR.
4. Press LEVEL FILE on the remote control. “FILE” will appear in the display for about 1 second, after which the volume level will be displayed for about 2 seconds (from a maximum of “0” to a minimum of “-50”; see 29. VOLUME on the next page for more details on volume level).

5. The volume level is now “filed” in the SD/A-390t memory. Whenever this disc is loaded, its level setting will be displayed for approximately 2 seconds at the beginning of playback.

The variable output level for up to 100 discs can be stored in the memory. Once the memory is full, if a new disc is loaded and the LEVEL FILE button pushed, “FULL” will be displayed for about 1 second to indicate that no more levels can be stored.

To store the level of a new disc, you must clear the level for a disc that has been previously stored in memory.

**To Clear Levels in Memory** – Load the disc whose level you want to clear and press PLAY. Press the LEVEL FILE button on the remote control. While “FILE” is being displayed press the CLEAR button. “CLER” will be displayed for about 1 second to indicate that the level for that disc has been cleared from memory.

- ✎ **Note:** When a disc is selected that has not had its volume level stored in memory, it will be played back at the volume setting of the most recent disc that was played.

If you are listening to a disc with the variable volume set very low, and the next disc has had its volume level stored at a very high level, obviously there will be a drastic difference in volume. If the difference in volume level from one disc to another is +15 units (+22.5 dB) or greater (see 29. VOLUME on the next page), the volume will increase gradually to avoid an abrupt and unanticipated increase in volume.

If the remote control is lost or disabled, the volume level can be reset to the maximum “0” by pressing and holding the DISC SELECT 2 button and then pressing the STOP button, while in the STOP mode.

### 26. CLEAR

This button is unique to the remote control and is used along with the LEVEL FILE button to clear previously stored volume levels from the SD/A-390t's memory. See *To Clear Levels in Memory* above.

## SD/A-390t

### 27. CALL

This button is unique to the remote control and is used to check the tracks in a programmed sequence. Press the CALL button once to see the first track stored in the program memory. Each time the CALL button is pressed the display will increment to the next track stored in the program memory. After the last programmed track is displayed, it will start over with the first programmed track.

### 17. PROGRAM

This button operates the same as the PROG/DIRECT button on the front panel. Pressing it once puts the SD/A-390t into Program Mode. Pressing it again puts it back into Direct Play Mode and clears the program memory.

Refer to page 14 for details on programming a sequence of tracks for playback.

### 18. EQ

This button operates the same as the SOFT EQ button on the front panel. Pressing this button engages the Soft EQ circuitry and causes the indicating LED next to the SOFT EQ button to light. Press the button again to turn the Soft EQ circuit off.

### 15. Disc Select Buttons

These buttons operate the same as the DISC SELECT buttons on the front panel. Pressing one of these buttons will cause the SD/A-390t to load the selected disc and begin playing it immediately.

### 16. Track Select Buttons

These buttons operate the same as the Track Select buttons on the front panel. Pressing one of these buttons from STOP mode will cause the SD/A-390t to begin playback at the beginning of the selected track. The "0" button corresponds to the "10" button on the front panel, and selects the tenth track.

For track numbers between 10 and 20, push the +10 button followed by a 1 - 9 button. For example, to select track 15, press the +10 button followed by the 5 button. For track numbers between 20 and 30, push the +10 button twice followed by a 1-9 button.

Pressing these buttons during playback will cause the laser pickup to move to the selected track and begin playing it immediately. Pressing these buttons during PAUSE mode, will cause the laser pickup to move to the selected track and wait until either the PAUSE button is pressed again or the PLAY button is pressed.

### 10. DISC - SKIP +

The "+" button operates the same as the DISC SKIP button on the front panel, causing the carousel to move forward to the next loaded disc position. Pressing the "-" button causes the carousel to move backward to the previous loaded disc position.

### 29. VOLUME ▲ ▼

These buttons are unique to the remote control. These control the output volume at the VARIABLE OUTPUT jacks. They have no effect on the FIXED OUTPUT or the PHONES output.

Press the ▲ button to increase the volume, and press the ▼ button to decrease the volume.

The volume level is displayed in units from 0 to -50. Each unit is equal to a change in volume of about 1.5 dB. When the volume level is set to "0", it is the same as the FIXED output. Thus, "-50" is about 75 dB below the FIXED output level.

Each time one of the VOLUME buttons is pushed, the new volume level is displayed for about 2 seconds.

The volume level will remain where it is set until either it is manually changed by adjusting the VOLUME buttons, or a disc is loaded that has had its level stored in the SD/A-390t's LEVEL FILE (see 25. LEVEL FILE on page 17).

## SD/A-390t

### 7. About Soft EQ

While compact discs represent the first significant improvement in audio sound sources since the stereo phonograph record, they are not without their variations and, subsequently faults.

Just as Bob Carver has addressed problems inherent in processes such as FM broadcast reception, power amplification and stereo, so has he taken a realistic and scientific approach to restoring certain sound deficiencies which can be present in AAD (Analog/Analog/Digital) compact disc.

Deficiencies? Yes. Any manufacturing process is variable. Mastering (the process of transferring the analog master tape to digital) is even more variable, since it consists of many subjective decisions made by a mastering engineer during the conversion process. In short, all compact discs don't sound the same.

Many professional musicians, audiophiles and audio journalists, while praising the quietness and dynamic range of compact discs, have often expressed a lingering disappointment in the way music sounds on many AAD examples. This is particularly evident when the compact disc is compared with a well-executed vinyl version of the same master tape! The complaints generally center around a particular compact disc's lack of ambience and spatial detail. In addition, the midrange is often described as sounding bright, hot and harsh.

When Bob Carver began comparing CDs to quality vinyl discs played with an audiophile turntable/cartridge combination, he, too, was dismayed by the compromises he heard on some discs. The lush, abundant, three-dimensional perspective which his turntable and cartridge provided suddenly evaporated into a flat, brittle wasteland. He immediately purchased a large number of compact discs which had well-mastered, well-pressed vinyl counterparts and set about quantifying the differences.

#### Ambient information deficiency

To quantify "stereo perspective", which is actually the L-R component of the signal, Bob devised a special test circuit that would amplify the difference. The figures below show the Lissajous oscilloscope patterns obtained from the same instant of musical program in its LP and CD versions.

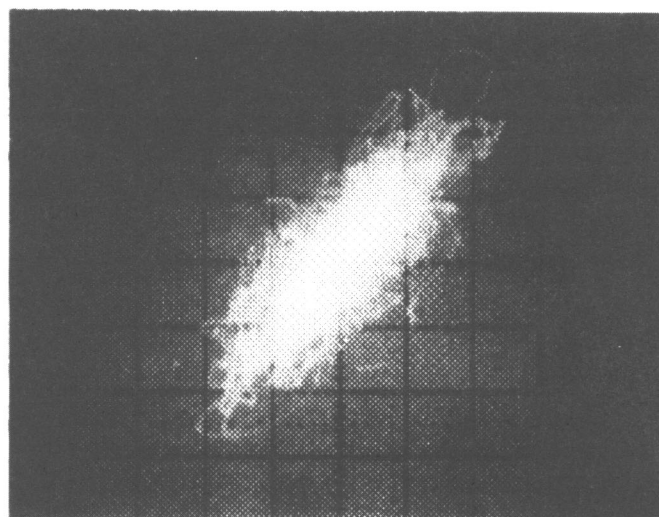

LP Version

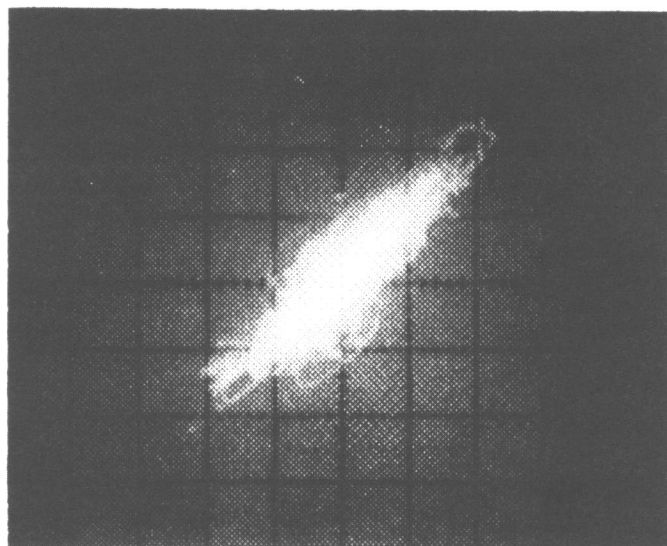

CD Version

Reprinted with permission of *Audio Magazine*

In this type of display, a straight, thin diagonal line from the lower left to the upper right would represent a purely monophonic signal. The more stereo “difference” information there is, the more the line spreads out into an ellipse. Notice that there is considerably more difference (L-R) signal in the LP version of the music! In fact, *the average amount of Left-minus-Right channel information versus the amount of Left-plus-Right differed by about 1.25dB between analog and digital versions of the same music.*

It is important to understand that the Left-minus-Right (L-R) component of the stereo carries the three-dimensional part of sound field information, much as is done with FM stereo. A reduction of 1.25dB doesn't sound like much. But since power goes up as the square of the voltage, it means that analog records carry a whopping thirty-three percent more ambience information than digital discs. That's a noticeable difference in three-dimensionality, imaging and other psychoacoustic factors that put the realism into music.

### Equalization differences

In addition, Bob discovered that many CDs exhibit a significantly different spectral energy balance than an analog version of the same music. Using a fine, moving-coil cartridge to play the LP versions of certain programs, Carver noted that there was a slight BOOST in the mid-bass region and a slight CUT in the mid-treble region compared with the response obtained when playing the CD version of the same program. In other words, the overall frequency response is shifted on the CD towards more midrange above 400 Hz.

Even today after a decade of accumulated compact disc mastering and production experience, these two fundamental CD deficiencies show up on many releases, especially those which have been prepared from older analog sources.

### How does Soft EQ correct these problems?

Bob Carver's circuitry adjusts the ratio of L-R to L+R and restores the octave-to-octave balance originally intended by the musician and recording engineer as evidenced by the analog recording.

Do all CDs need Soft EQ's effect? No. In fact, with some speaker systems which don't image as well as they could, almost no difference can be detected. That said, we must point out that, on the right CD – and there are many of them which qualify – the discriminating listener will immediately notice a significant improvement. As one reviewer put it, *“I suspect that many owners will put little marks on their CDs that indicate whether they should be played with the Time Lens (Soft EQ) or not. I find nothing wrong with such an arrangement.”*

## SD/A-390t

### 8. In Case of Difficulty

If you're having trouble or suspect a problem with the SD/A-390t, try some simple troubleshooting before contacting your Carver dealer or an Authorized Carver Service Center. Most likely, the problem lies elsewhere in the system or with a button or control inadvertently left in the wrong position.

#### No Sound, No Power.

1. SD/A-390t power is off.
2. SD/A-390t is plugged into a switched convenience outlet. Verify that component is turned on and the outlet is live.
3. Linecord is disconnected.
4. Poor fit between the plug and wall receptacle.
5. Power off at wall receptacle (check with tester or lamp).

#### Power On, Playback will not begin.

1. The disc is upside down. Reload the disc with the label side up.
2. The disc is dirty or damaged.
3. If the SD/A-390t has been brought into a warm room from a cold area, condensation can occur on the laser pickup. Allow the player to warm up to room temperature.

#### No sound from one or both channels.

1. Loose or defective hook-up cables. Check the output cables for proper connection. If necessary, substitute a known good set to find a bad one.
2. Preamplifier or receiver not set correctly.
  - Is the correct source selected?
  - Are the volume and balance controls set right?
  - Is the muting function activated?
  - Is the tape monitor button pushed in?
  - Is there a Speaker A/B Select switch? Are the correct pair of speaker outputs selected?
  - Is the power amplifier turned on?

3. Incorrect connection. Are BOTH left and right outputs from the SD/A-390t connected to the correct inputs on the preamplifier or receiver?

#### Playback is mixed with hum.

1. Check or replace the connecting cables.
2. Make sure that each cable plug is securely pushed into its socket.
3. Signal cables may have been routed too closely to AC cables, power transformers, motors or TV sets.
4. Try relocating the SD/A-390t, allowing more space between it and your receiver, integrated amp or power amplifier.
5. Listen to other preamplifier sources. If the hum persists, it's not the CD player's fault.

#### Sound skips or stutters.

1. The SD/A-390t is receiving excess vibrations or physical shock. Read the recommendations on pages 6 and 7 about correct placement.
2. Bad disc. Check the disc for dirt or scratches.

#### 0 00 00<sub>M</sub> 00<sub>S</sub> is displayed after a disc is loaded.

1. Bad disc. The compact disc is not providing lead-in information or is not compatible. Check the disc for damage or try another disc that you know works. Replace the disc if necessary.
2. Disc is inserted label side down. Be sure the label side is up.

#### Remote Control Won't Work

1. Batteries are dead or missing.
2. Remote is too far from or at too much of an angle from the remote sensor window on the SD/A-390t.
3. Remote transmitter or the remote sensor window on the SD/A-390t is dirty.

**SD/A-390t**

## 9. Care and Service Assistance

### Care

You'll want to wipe off the SD/A-390t's front panel and chassis from time-to-time with a soft, dry cloth. If you have something stubborn to remove, use a mild dish soap or detergent sparingly applied to a soft cloth. Don't use alcohol, ammonia, or other strong solvents.

### Service Assistance

We suggest that you read the LIMITED WARRANTY completely to fully understand your warranty/service coverage. Please promptly complete and return the WARRANTY REGISTRATION CARD. Also be sure to save the sales receipt in a safe place. It will be necessary for warranty service.

If your CARVER product should require service, we suggest you contact the Dealer from whom you purchased your unit. Should the Dealer be unable to take care of your needs, you may contact the CARVER Technical Service Department by phoning (206) 775-6245 or by writing to us at the Factory address shown at the right. We will then direct you to the nearest in our national network of Authorized Warranty Service Centers or give you detailed instructions on how to return the product to us for prompt action.

If you should have questions or comments, please write to the Factory address given below. Please include the model and serial number of your Carver product, your complete address and a daytime phone number.

### Factory Address

Carver Corporation Service Department  
P.O. Box 1237  
Lynnwood, WA 98046-1237  
(206) 775-6245

Carver Corporation reserves the right to improve its products at any time. Therefore, specifications are subject to change without notice.

© 1993 Carver Corporation. All rights reserved.

Pub #921106-A  
Part #990-20174-00 Rev. A

Written and designed in the United States of America.

Printed in Japan.



# CARVER

***Powerful • Musical • Accurate***