

Bob Carver's
Sunfire
...from his mind & soul

*Classic
Vacuum Tube
Preamplifier*

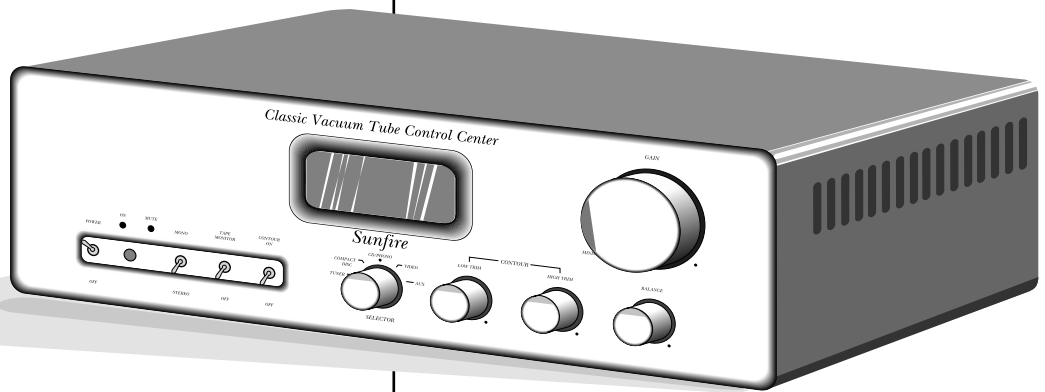

User's Manual

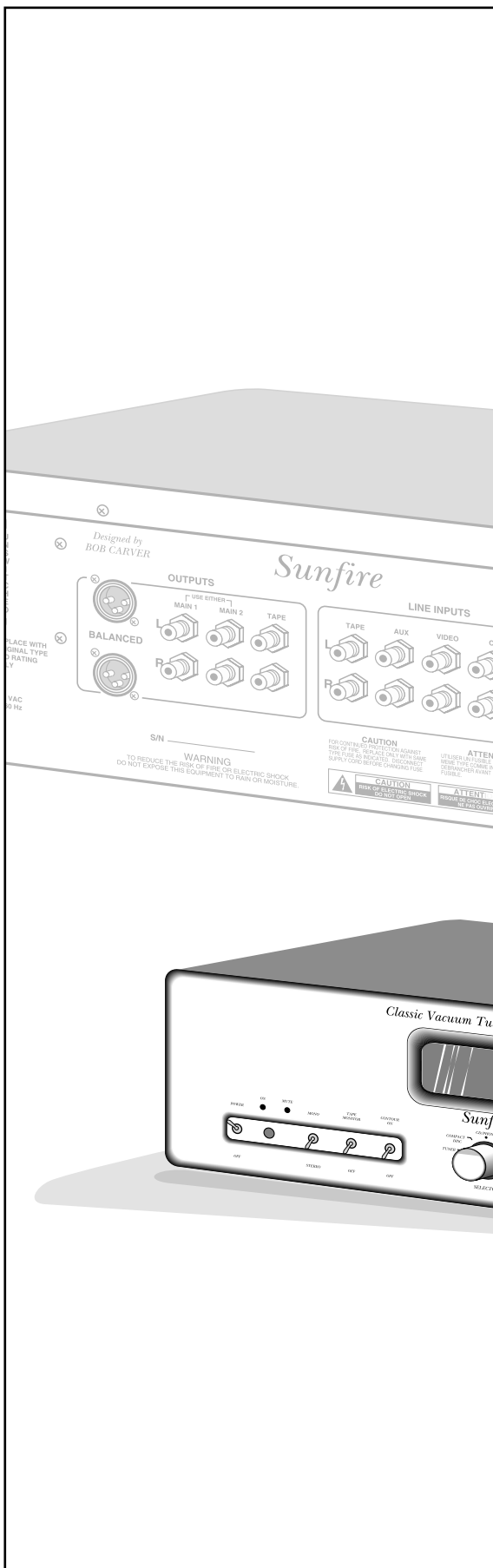
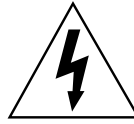
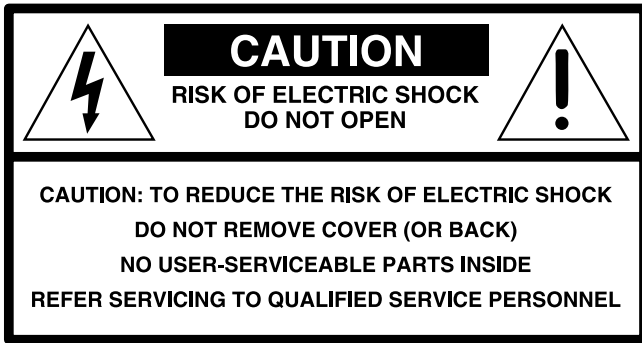

The lightning flash with arrowhead symbol within an equilateral triangle is intended to alert the user to the presence of uninsulated "dangerous voltage" within the product's enclosure, that may be of sufficient magnitude to constitute a risk of electric shock to persons.



The exclamation point within an equilateral triangle is intended to alert the user of the presence of important operating and maintenance (servicing) instructions in the literature accompanying the appliance.

Safety Instructions

- 1. Read Instructions** — All the safety and operation instructions should be read before the Sunfire Component is operated.
- 2. Retain Instructions** — The safety and operating instructions should be kept for future reference.
- 3. Heed Warnings** — All warnings on the Component and in these operating instructions should be followed.
- 4. Follow Instructions** — All operating and other instructions should be followed.
- 5. Water and Moisture** — The Component should not be used near water - for example, near a bathtub, washbowl, kitchen sink, laundry tub, in a wet basement, or near a swimming pool, etc.
- 6. Ventilation** — The Component should be situated so that its location or position does not interfere with its proper ventilation. For example, the Component should not be situated on a bed, sofa, rug, or similar surface that may block any ventilation openings; or placed in a built-in installation such as a bookcase or cabinet that may impede the flow of air through ventilation openings.
- 7. Heat** — The Component should be situated away from heat sources such as radiators, or other devices which produce heat.
- 8. Power Sources** — The Component should be connected to a power supply only of the type described in these operation instructions or as marked on the Component.
- 9. Power Cord Protection** — Power-supply cords should be routed so that they are not likely to be walked upon or pinched by items placed upon or against them, paying particular attention to cords at plugs, convenience receptacles, and the point where they exit the Component.

10. Cleaning — The Component should be cleaned only as recommended in this manual.

11. Non-use Periods—The power cord of the Component should be unplugged from the outlet when unused for a long period of time.

12. Object and Liquid Entry — Care should be taken so that objects do not fall into and liquids are not spilled into the inside of the Component.

13. Damage Requiring Service — The Component should be serviced only by qualified service personnel when:

- A. The power-supply cord or the plug has been damaged; or
- B. Objects have fallen, or liquid has spilled into the Component; or
- C. The Component has been exposed to rain; or
- D. The Component does not appear to operate normally or exhibits a marked change in performance; or
- E. The Component has been dropped, or its cabinet damaged.

14. Servicing — The user should not attempt to service the Component beyond those means described in this operating manual. All other servicing should be referred to qualified service personnel.

PORTABLE CART WARNING



Carts and stands - The Component should be used only with a cart or stand that is recommended by the manufacturer. A Component and cart combination should be moved with care. Quick stops, excessive force, and uneven surfaces may cause the Component and cart combination to overturn.

15. To prevent electric shock, do not use this polarized plug with an extension cord, receptacle or other outlet unless the blades can be fully inserted to prevent blade exposure.

Pour prévenir les chocs électriques ne pas utiliser cette fiche polarisée avec un prolongateur, une prise de courant ou une autre sortie de courant, sauf si les lames peuvent être insérées à fond sans laisser aucune partie à découvert.

16. Grounding or Polarization — Precautions should be taken so that the grounding or polarization means of the Component is not defeated.

This apparatus does not exceed the Class A/Class B (whichever is applicable) limits for radio noise emissions from digital apparatus as set out in the radio interference regulations of the Canadian Department of Communications.

ATTENTION — Le présent appareil numérique n'émet pas de bruits radioélectriques dépassant les limites applicables aux appareils numériques de class A/de class B (selon le cas) prescrites dans le règlement sur le brouillage radioélectrique édicté par les ministères des communications du Canada.

WARNING: TO REDUCE THE RISK OF FIRE OR ELECTRIC SHOCK, DO NOT EXPOSE THIS APPLIANCE TO RAIN OR MOISTURE.



WARNING: ALWAYS FULLY INSERT THE PLUG INTO THE AC SUPPLY SOCKET.



Contents

Safety instructions	2-3
Introduction	4
Features	4
Unpacking	4
Overview	5
Front panel features	6-7
Rear panel features	8-9
Installation, AC power and connections	10
Care	10
The Phono stage	11-12
System Configurations	13
Phono connections	13
CD player connections	14
Tape deck connections	15
Amplifier connections: unbalanced	16
Amplifier connections: balanced	17
Specifications	18
Troubleshooting guide	19-21
Appendix	22
Changing the phono stage gain	22
Changing the phono stage input impedance	22
Tube type and location	22
Limited Warranty	23
Service assistance	23

To find out more about this and other Sunfire products,
please visit our website: www.sunfire.com

Introduction

Dear Friend,

Congratulations on your purchase of the Sunfire Classic Preamplifier. We believe its sophisticated engineering and meticulous craftsmanship will provide you with many years of listening enjoyment.

At the heart of the Classic is a high-performance control preamplifier with extremely low noise and distortion, wide dynamic range, and a high degree of control flexibility. An optional phono board may be added for precise RIAA phono equalization of moving magnet and moving coil cartridges. Your Classic will provide remarkable three-dimensional realism, with a sumptuous sonic image which can extend beyond the loudspeakers in both breadth and depth.

Bob Carver

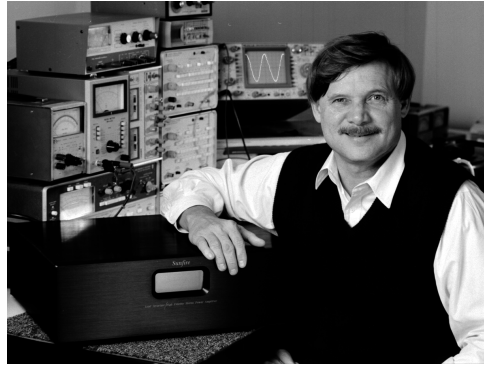

Bob Carver, Amplifier Designer, Physicist

Unpacking

Your Classic preamplifier should reach you in perfect condition. If you do notice any shipping damage, please contact your Sunfire Dealer immediately.

Gently remove the Classic preamplifier from its packing materials with care, so as to avoid damage to or loss of any packing materials. This is a precision instrument and deserves to be treated with care. It has been designed to provide years of reliable service, and should you ever need to ship or transport it, the original packing materials will provide the safest means.

Make sure that you keep your sales receipt. It is the only way to establish the duration of your Limited Warranty and it may come in useful for insurance purposes.

Please take a moment to fill out and mail the Sunfire Warranty Registration card. Also read the serial number located on the rear panel and record it here:

Serial Number:	_____
Purchased from:	_____
Date:	_____

Features

- High quality vacuum tube design
- 6 L/R pairs of unbalanced inputs
- Optional MM and MC Phono section
- 2 pairs of unbalanced main outputs
- 1 pair of balanced outputs
- 1 pair of tape outputs
- Low frequency contour control
- High frequency contour control
- Tape monitor switch
- Stereo/mono switch
- Motorized volume control
- Balance control
- Remote control of volume, mute and power
- 3 unswitched AC outlets
- Gold-plated inputs and outputs
- Classic chassis and styling

Overview

The Classic is a preamplifier control center. If you have previous experience with stereo components, you can probably complete the input/output connections and make normal use of the basic preamplifier functions without special instructions. We recommend, however, that you read the entire manual at your earliest convenience. You will find that even some of the "conventional" parts of the Classic are in fact not conventional at all.

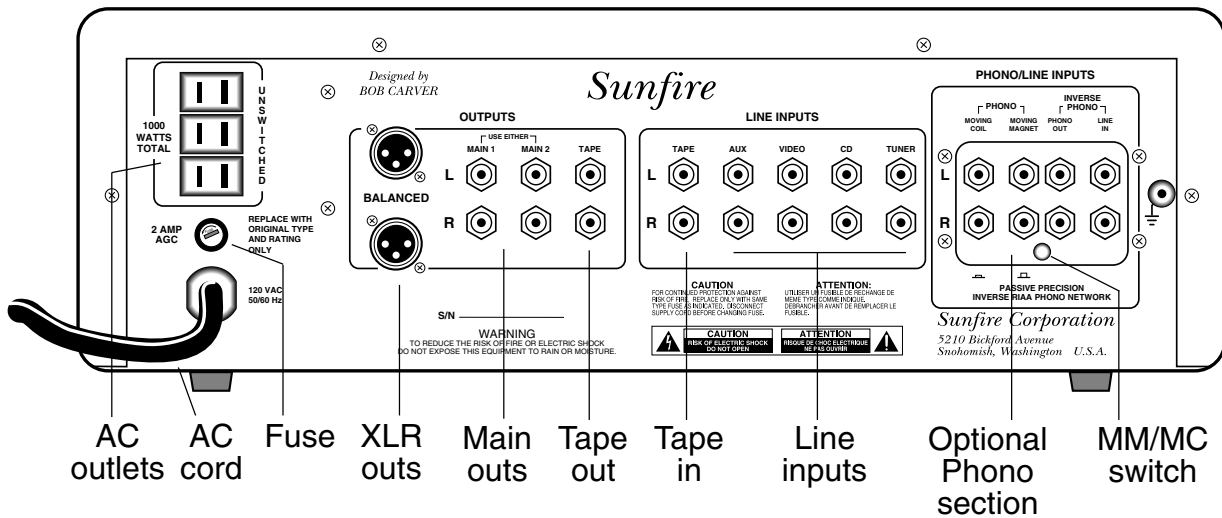
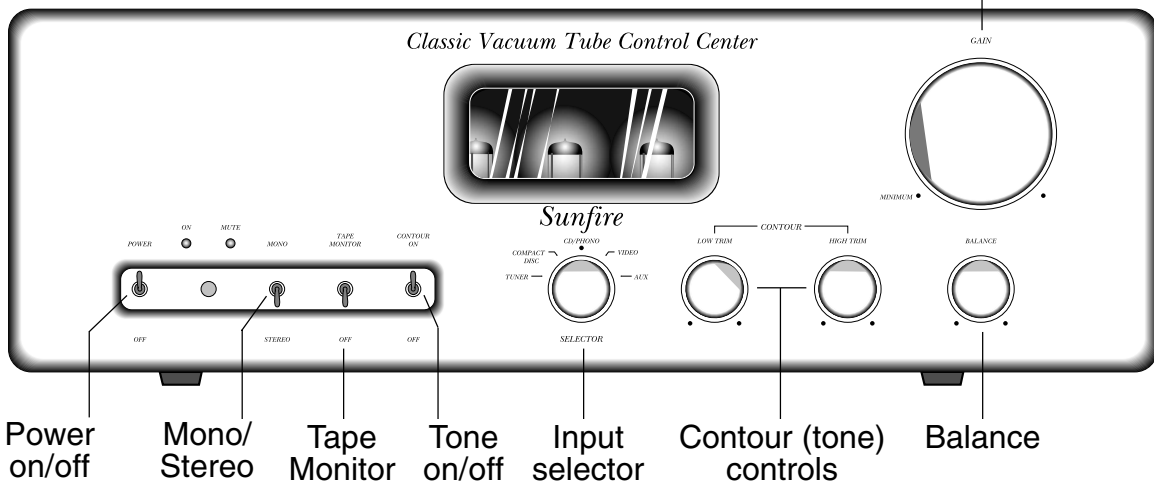
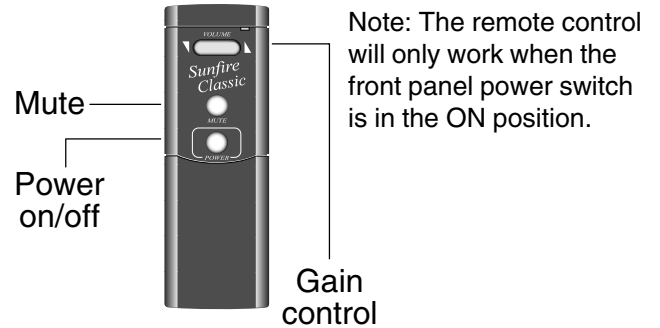

Front Panel Features

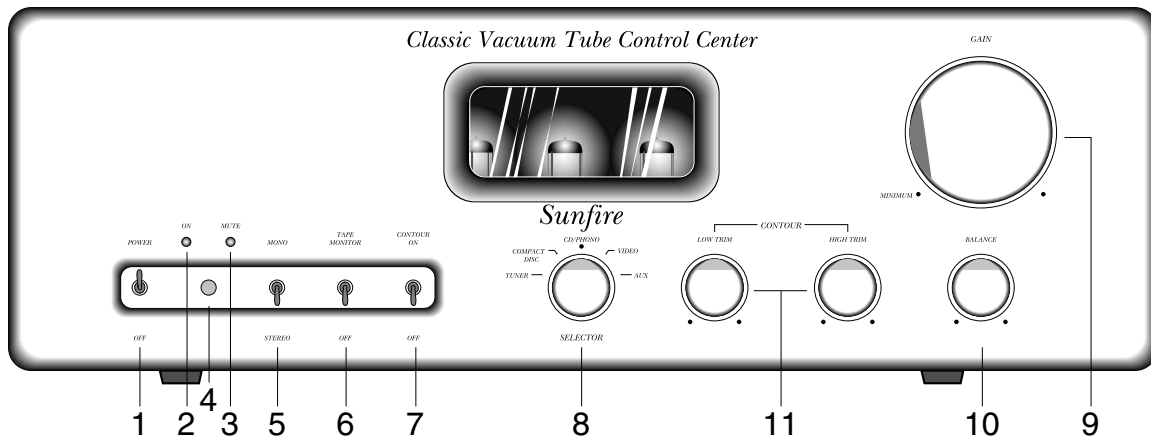

1. Power Switch

This is the main AC power switch. Flip the switch up to apply power to the unit. It is good practice to turn the volume control down before turning on, and keep it down until after about 40 seconds of tube warm-up time (when the MUTE lamp turns off, and the ON lamp stops blinking and turns on continuously).

If you prefer, you may leave this AC power switch permanently on, and use the remote control to switch the unit on or off. Turning the power off with the remote will extinguish both the MUTE and ON lamps.

Note: the power switch must be in the up (POWER) position for the remote control to work.

2. On lamp

During normal operation this lamp will be on. When you turn the preamplifier on, this lamp blinks for about 40 seconds while the tubes are warming up. After that time, it will stay on continuously.

3. Mute lamp

During normal operation, this lamp will be off. When you turn the preamplifier on, this lamp stays on for about 40 seconds while the tubes are warming up, indicating that the outputs are muted and no sound is passed to your amplifiers. The lamp will also indicate whenever the remote control MUTE is pressed.

If you accidentally turn off the preamplifier using the remote, you can quickly turn it back on. The preamplifier will automatically sense that there is no need for a 40 second mute because the tubes are already warmed up.

4. Remote window

This window should be kept clear of obstruction for the remote control to work.

5. Stereo/Mono Switch

This sums the left and right inputs so the main outputs will have identical signals. (It does not affect the Tape outputs).

The most common use for this switch is in checking loudspeaker phasing: Play any stereo or mono recording, select Mono and listen. Then reverse the polarity (+, -) of one speaker connection and recheck. The polarity position which develops a clear center image between the speakers with fullest bass content is the correct "in-phase" position of the speaker wiring.

You should also engage Mono for playback of old monophonic sources, since this will cancel most rumble and noise for quieter playback.

When listening to a single-channel source, you can either use a "Y" cord at the selected input, or select Mono.

6. Tape Monitor switch

This will connect the output of a recorder to the subsequent preamplifier circuitry. It may be used for tape playback or record-monitoring with three-head recorders. Similarly, if a signal processor is connected to the preamplifier's Tape inputs and outputs, it will be in circuit whenever the Tape Monitor switch is engaged.

7. Contour On/Off

In the OFF position, the contour circuits are bypassed and the two contour controls (11) will have no effect.

In the ON position, the signal frequency response can be adjusted by the contour controls to suit your taste.

8. Input Program Selector

This rotary switch selects the program source which will be heard. The same program source is also presented to the Tape outputs for recording. Note that there is no Tape selection, you should engage the Tape Monitor switch to listen to your tape deck.

If you have the optional Phono input, select either MM or MC using the rear panel switch (depending upon your phono cartridge), and then select CD/Phono.

To minimize bleedthrough, or an audible signal when you select an unused input, it is recommended that "shorting plugs" be inserted in all unused inputs. Do Not install shorting plugs in any OUTPUT jacks, as this would short-circuit the preamplifier output. If you do not use shorting plugs, that is perfectly OK., and you can prevent bleedthrough by turning off or muting all signal sources not being listened to.

9. Volume Control

This is the master level control for the stereo system. The control is a continuous taper potentiometer to allow smooth transition from one level to another.

The taper rate of the potentiometer was chosen to provide maximum flexibility and compatibility with other components. Input signal levels will vary from one source to the next, as well as from one disc, tape, or FM station to the next, so it is normal to notice that your preferred volume control setting varies.

Note: The remote control's Volume Up function is disabled when the system is muted or warming up. This is to prevent causing damage to your speakers due to accidentally high volume levels. The remote's Volume Down function is available at all times, and you can still set the volume at any time using the front panel control (but make sure it is turned down while the preamp is warming up).

10. Balance Control

This adjusts the relative levels of the two stereo channels. In its center position, the levels are exactly equal. Clockwise rotation reduces the Left channel level, while counterclockwise rotation reduces Right channel level. Small movements off-center produce smaller shifts in the stereo image per degree of rotation than near the extreme left and right position. This makes slight trimming of levels more convenient.

11. Contour Controls

The Sunfire Classic is equipped with a tone-control stage in the signal path after all input selection and tape switching. These controls are switches which select a variety of precise contour curves. In operation, a muted click or pop may be heard when changing switch positions. The controls may be switched in or out of circuit by the contour switch (7), allowing the contoured signal to be quickly compared with the preamplifier's laboratory-flat frequency response.

The contour controls are asymmetrical in boost and cut. They have been designed to be very appropriate for real music listening situations. The boost exhibits no shelving, and reaches a maximum of +6 dB at full clockwise rotation. Bass may thus be boosted without the boom associated with shelving, in order to increase deep punch without mid-bass fatness. Treble boost will field greater definition, without the shrillness which results from treble-boost shelving.

In the cut (counterclockwise) position, treble and bass are not rolled-off, as with most tone controls, rather energy output in the upper and lower ranges is reduced while maintaining flat frequency response in those ranges. Cut does not exceed -10 dB, since frequency response attenuation beyond this yields a dead sound character which is not musically advantageous. Cut is not substantially affected by the tone-turnover frequency switches. This shelving characteristic for the cut mode is very useful, for example, if a recording sounds too bright. The relative harmonic energy can be reduced without affecting the balance of the harmonic content. Thus, a violin will still sound like a violin, retaining its air, sheen and openness, while reducing excessive brightness.

Note: We encourage the routine use of the contour controls as this will significantly enhance your listening pleasure.

Rear Panel Features

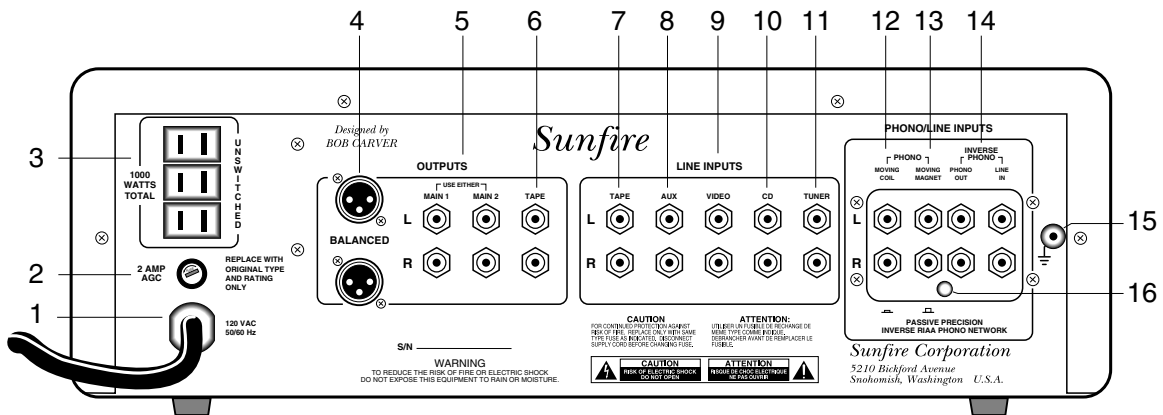

1. AC Line Cord

This is heavy-duty cord capable of carrying large currents required by high-power amplifiers. The Classic itself requires only modest power (equivalent to most light bulbs) and may thus be powered by a conventional extension cord if required. But if you have substantial power amplifiers connected to one of the convenience outlets, only use a heavy duty extension cord (16 gauge or thicker).

The line cord should only be plugged in after completing all input and output connections to other components.

If your power amp is not equipped with a power switch, make sure that the preamplifier's power switch is OFF (indicator LED is not lit) and its AC line-cord is unplugged, before connecting the power amp's line cord to one of the Classic's outlets.

2. Fuse



Always unplug the power cord before inspecting or changing the fuse. Never use a fuse with a larger current rating than 2 A.

4. Balanced outputs

These are the left and right outputs which connect to the balanced inputs of an amplifier used to drive your speakers.

Balanced outputs offer superior noise cancellation, especially if there is a long cable run to your amplifier.

3. Accessory outlets

These three unswitched AC outlets are LIVE whenever the unit's line cord is plugged into an active AC receptacle. They can be used to supply AC power to other components of your system, including your amplifier. The total power draw must not exceed 1000W.

Verify that all component power-switches are OFF before plugging any component line cords into these or any AC outlets.

5. Main 1 and Main 2 outputs

MAIN 1 - These are left and right unbalanced (RCA) outputs which connect to the unbalanced inputs of an amplifier used to drive your main front speakers.

MAIN 2 - Identical to Main 1. They can be used to drive a second power amplifier, such as in bi-wire or multiple speaker applications, to drive a subwoofer, or to feed processed signals to a tape recorder or a time-delay accessory.

6. Tape output

These outputs connect to the inputs of a tape deck for recording the source which is currently selected by the preamplifier.

Input jacks on your tape deck may be labeled "Line In", "Aux", or "Record", but do not use "Microphone."

It is recommended that DIN-type record/play sockets not be used if conventional RCA jacks are available at the recorder.

7. Tape input

This connects to the outputs of a tape deck for playing your favorite tapes through the preamplifier. This input is selected using the TAPE MONITOR switch, not by the Input selector control.

Tape deck output jacks may be identified as "Line Out", "Play", or "Monitor".

8. Aux input

These line-level inputs are electrically identical to the other line inputs, and may be used for signal sources such as a second tuner, a tape-deck, TV audio tuner, VCR or the output of a microphone preamplifier.

9. Video input

For connection of the audio output from a VCR, DVD, satellite tuner or TV.

10. CD input

For connection of the output from a CD player. This input is selected using the input selector's COMPACT DISC position. If your player has "fixed" and "variable" outputs, use the variable outputs. Then you can adjust the output level of the CD player so that when you switch from Phono to CD to Tuner, the volume level will remain approximately the same.

11. Tuner input

Connect to the line-level output from a FM or AM/FM tuner.

12. Moving Coil phono input

Connect to the output of a turntable equipped with a moving coil phono cartridge. Push the rear panel MM/MC selector button IN.

13. Moving Magnet phono input

Connect to the output of a turntable equipped with a moving magnet phono cartridge. Push the rear panel MM/MC selector button OUT.

14. Inverse-phono section

The Classic preamplifier allows you to play your CDs or other line level sources through the phono stage. It can also be used to check the phono stage operation.

The special wiring configuration and details for this circuit are described and illustrated on page 12.

15. Ground

Attach your turntable's ground wire to this point to prevent hum.

16. MM/MC selector

Push this IN if you are using the Moving Coil (MC) input. Push it OUT if you are using the Moving Magnet (MM) input.

Note

An additional line level input is available if the optional Phono stage has not been installed. This input (or the phono stage) is selected using the input selector's CD/PHONO position.

For more details of the Phono stage, see pages 11 and 12.

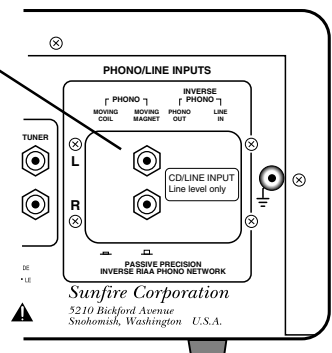

Installation

Observe the following precautions when choosing a location for your Classic vacuum tube preamplifier:

- The Classic is an all-vacuum tube design. It may be operated at any angle, and has modest ventilation requirements. Do not cover the side ventilation slots.
- Its location relative to other stereo components is not critical, except that it should not be stacked with, or placed adjacent to, powerful amplifiers which may generate external hum fields.
- Typically it is best to locate the Classic close to the turntable or CD player so that connection cables may be kept short. The turntable should be on a solid, vibration-free surface to avoid problems of acoustic feedback and instability. In many systems it may be convenient to locate the preamp within arm's length of the prime listening position, for which long cables to the amplifier will be necessary; normally, cable runs of up to 30 feet are OK.
- Protect it from prolonged exposure to direct sunlight and other direct sources of heat, such as heating vents and radiators.
- Do not expose the unit to rain or moisture. If fluid or a foreign object should enter the unit, immediately turn off the power and contact your Sunfire Dealer.
- Avoid excessive exposure to extreme cold or dust.
- Do not place heavy objects on top of the unit.

AC Power Considerations

Ensure that the unit is plugged into an outlet capable of supplying the correct voltage specified for your model.

Care

If you need to clean the front surface, first turn off the power and then use a slightly dampened cloth, rubbing with the grain. Be careful not to scratch the front window.

Connection Tips

Before setting up your new system, please consider the following :

- Before making or changing any connections, check the front panel to make sure the Power switch is DOWN (off), and that the Volume Control is set for no output (full counterclockwise). The amplifier and all other equipment should be turned off and the preamplifier line cord unplugged before making any connections.
- Whenever possible, keep the power cords away from the signal cables or speaker wires to prevent any hum or interference being heard in the speakers.
- Choose reliable interconnect cables, also called patch cords or RCA cables. They should be fully shielded and as short as possible for the job.
- If your amplifier has balanced inputs, then we recommend using the balanced outputs of the preamplifier as this will provide superior noise rejection.
- Some patch cords can be a very tight fit and there is usually a preferred method of getting them off, some have to be removed with a twisting action. Be gentle or you may damage the jacks of the amplifier or your other components.

The Phono stage

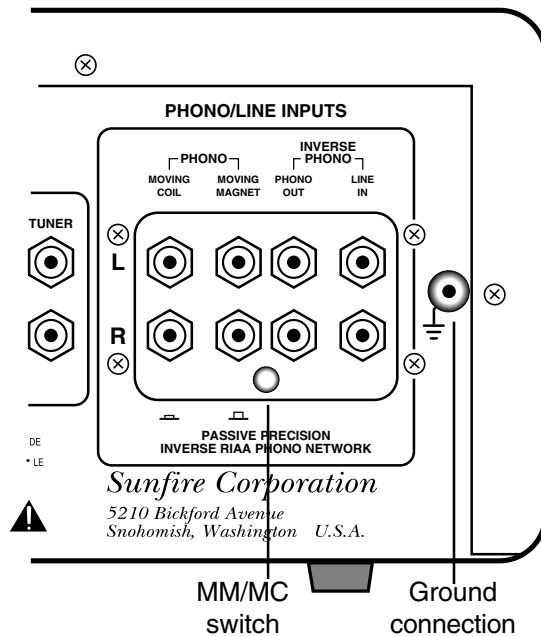

The optional phono stage contains two independent stereo phono preamplifier inputs which are optimized for specific uses. The type of phono cartridge you are using in the turntable will determine which phono input to use. Only a moving coil cartridge should be connected to the moving coil input, or it may become overloaded and distort.

In terms of frequency response, the moving coil and the moving magnet phono are identical. In terms of gain and sensitivity, however, they differ substantially.

Ground connection

If your turntable is equipped with a separate ground lead (usually a single wire terminated with a spade lug), connect it to the ground post, (see item #15 on page 8). In most cases, this will minimize audible hum and buzz in the phono signal. If hum is a problem with your turntable, refer to the troubleshooting section starting on page 19.

Normally, these are the only connections made to the ground post, while all other components are grounded through their own signal cables.

Moving Magnet phono input

The rear panel MM/MC selector button must be OUT for moving magnet cartridges.

The moving magnet phono circuit has a total gain of 40dB, appropriate for typical high output moving magnet and moving iron cartridges.

Its input impedance consists of 47K ohms resistance in parallel with real capacitance. This prevents the complex input interactions which can cause small response shifts in some systems. When plugging the cables into the Classic's sockets, be sure each plug is inserted fully into the socket, making a tight fit.

You can plug the turntable line cord into one of the accessory outlets on the rear panel of the Classic preamplifier.

Moving Coil phono input

The rear panel MM/MC selector button must be IN for moving coil cartridges.

The two inputs marked MC are intended for use with moving coil cartridges only. This Phono circuit employs an additional 20dB of linear gain (for a total of 60 dB to Tape Outputs), designed especially for the relatively low voltage output of moving coil cartridges. The Classic employs a built-in "pre-amplifier", but this design is free of the compromises usually associated with active gain at this stage.

Historically, the problem of obtaining the extra gain required for the moving coil cartridge has been an expensive proposition. The problem has been as follows: To obtain low noise, a step-up transformer has been required, transforming the low cartridge impedance up to the 47K ohm input impedance of the phono stage. In this process, the noise floor of the system is generally established by the 3 to 10 ohm source resistance associated with the moving coil cartridge, and is therefore very low. However, in order to obtain signal performance comparable to even simple active electronic circuits, heroic

efforts on the part of the transformer designer are required, and the resulting cost will almost always be many hundreds of dollars. Less expensive transformers will be quiet, but will usually exhibit ringing, phase shift, and some low frequency distortion. The problems with most active step-up devices are simply reversed. Moderate cost, smooth high-frequency response, essentially zero phase shift and low distortion may almost be taken for granted, while heroic and expensive design techniques, including cryogenic cooling, have been required to even approach the low noise of a transformer.

A superbly accurate dual parallel input, combined with the use of high current tubes which exhibit an almost unheard-of noise figure at room temperatures, made a new "super-gain" phono stage possible. It yields all the performance advantages of active circuits, with noise levels within 6 dB of the best transformers, all at moderate cost and at room temperature.

To change the gain or the input impedance of your phono stage please refer to the Appendix on page 22.

Infrasonic Filter

This circuit corrects for difficulties often encountered with phono disc playback.

The Infrasonic Filter is an 18 dB per octave design. Its response is flat down to 10Hz, then attenuates the preamp's frequency response rapidly at lower frequencies. Phono playback is inevitably contaminated to some extent by sub-sonic energy, due to normal amounts of record warp, tonearm/cartridge resonance and turntable motor rumble. If not filtered out of the audio signal, this sub-audible energy can overload tape recorders, waste amplifier power, and drive woofers into excessive cone excursions, causing intermodulation distortion audible as muddy bass.

Normally, "group delay", an unavoidable consequence of the rapid attenuation of sub-sonic response, can, under certain musical

circumstances, have a just perceptible consequence in the audio passband. Infrasonic filtering is thus often somewhat of a compromise. In order to eliminate this problem, the onset of rolloff has been delayed a full octave below 20 Hz, effectively reducing group delay to well below the threshold of audibility.

Precision Inverse RIAA Network

A wonderful and classic pleasure in this day and age of digital audio is to listen to vinyl records, which were made using the RIAA equalization curve. Ordinarily of course, with CDs that's not possible. The next best thing, however, is to use your Sunfire's Precision Inverse RIAA network to listen to CDs through its classic vacuum tube phono stage:

- Connect the output of your CD player to the line-input of the inverse phono network.
- Connect the phono output of the inverse phono network to the input of the MM phono stage, using a short interconnect cable.
- Make sure that the MM/MC selector button is OUT to select the MM input.
- Set the front panel selector switch to CD/Phono; and "Voilà", RIAA sound from CDs!
- This mode also allows a line source to be used to check that the MM phono stage is working correctly.

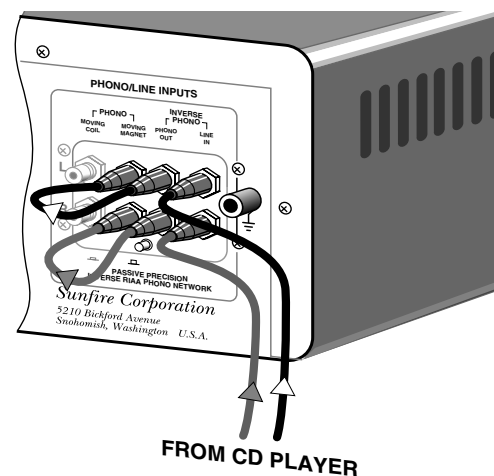

System Configurations

The following pages show some typical connections that you might make in your installation. They show how the inputs and outputs of the Classic preamplifier are connected to various audio components.

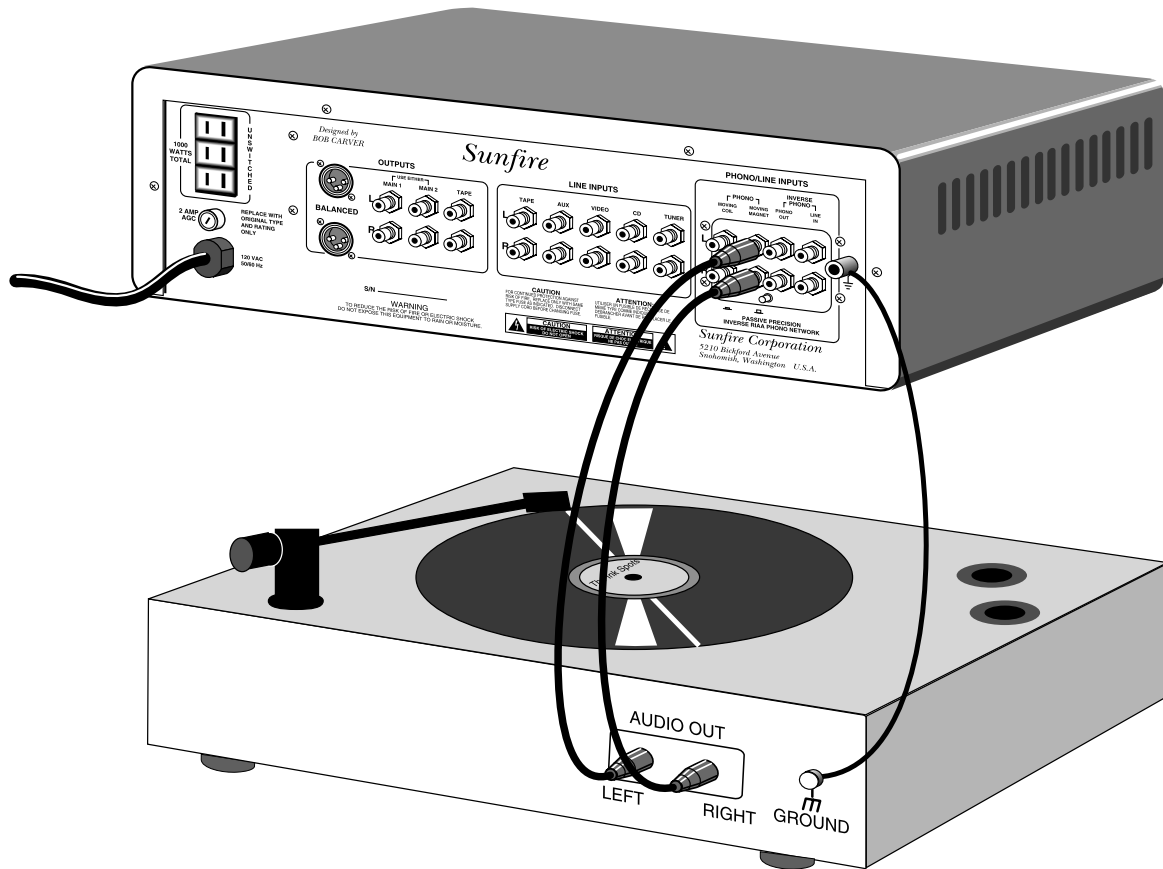

If your turntable is equipped with a Moving Magnet cartridge, connect its audio outputs to the preamplifier's Moving Magnet inputs as shown. Make sure that the MM/MC button is in the OUT position.

If you have a Moving Coil cartridge, use the preamplifier's Moving Coil inputs and push the MM/MC button inwards.

Phono Connections

In most cases, the turntable ground wire should be connected to reduce any hum heard in the speakers.

Never connect a line-level source component directly to the preamplifier's MC or MM inputs as they will be overloaded. They are specially designed to handle only the very low level outputs from a phono cartridge, and not the higher voltage outputs from CD players or other line level components. (Phono level is usually below 100mV, whereas line level can be up to 2 volts).

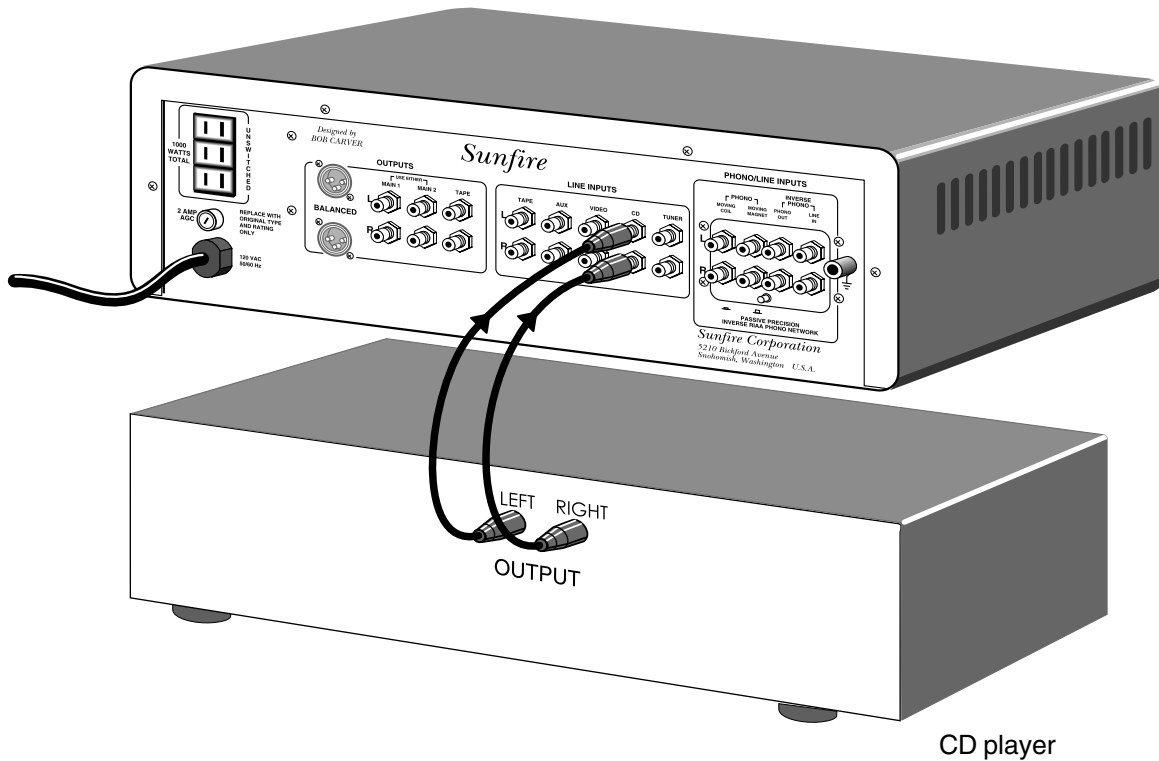

The audio output from your CD player can be connected to the preamplifier's CD inputs.

If your CD player has variable outputs, this will allow you to adjust the CD player's output volume to match the volume of other components in your system, such as the tape deck or turntable. When you switch from one component to the next, the initial volume would then be similar.

If you want your CD player to have an extra special sound, you can use the Inverse RIAA circuits as shown on page 12.

Any of the line level inputs, such as TUNER, CD, VIDEO, AUX and TAPE can be used by any source component with a line level output, such as DVD, LaserDisc, VCR, reel-to-reel, DAT, TV or satellite receiver.

CD player Connections

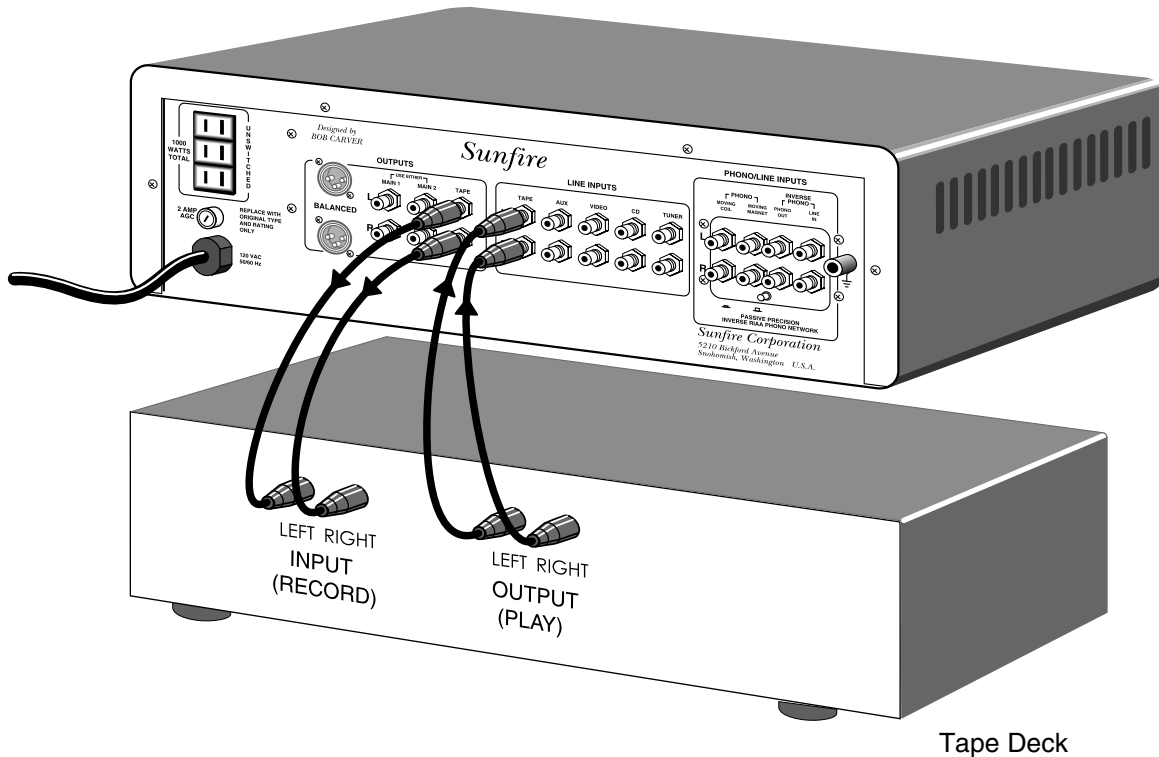

Tape Deck

The output from your Tape deck connects to the preamplifier's TAPE inputs. These inputs are only selected by using the preamplifier's Tape Monitor switch.

The inputs of your Tape deck connect to the preamplifier's TAPE outputs. These outputs are unaffected by the setting of the volume control or the contour controls.

An external processor can be connected in exactly the same way as a Tape deck:

- The external processor outputs connect to the preamplifier's Tape inputs.
- The external processor inputs connect to the preamplifier's Tape outputs.
- Select the source you would like to listen to, such as CD, and then select the Tape Monitor switch to listen to the processed sound.

Tape Deck Connections

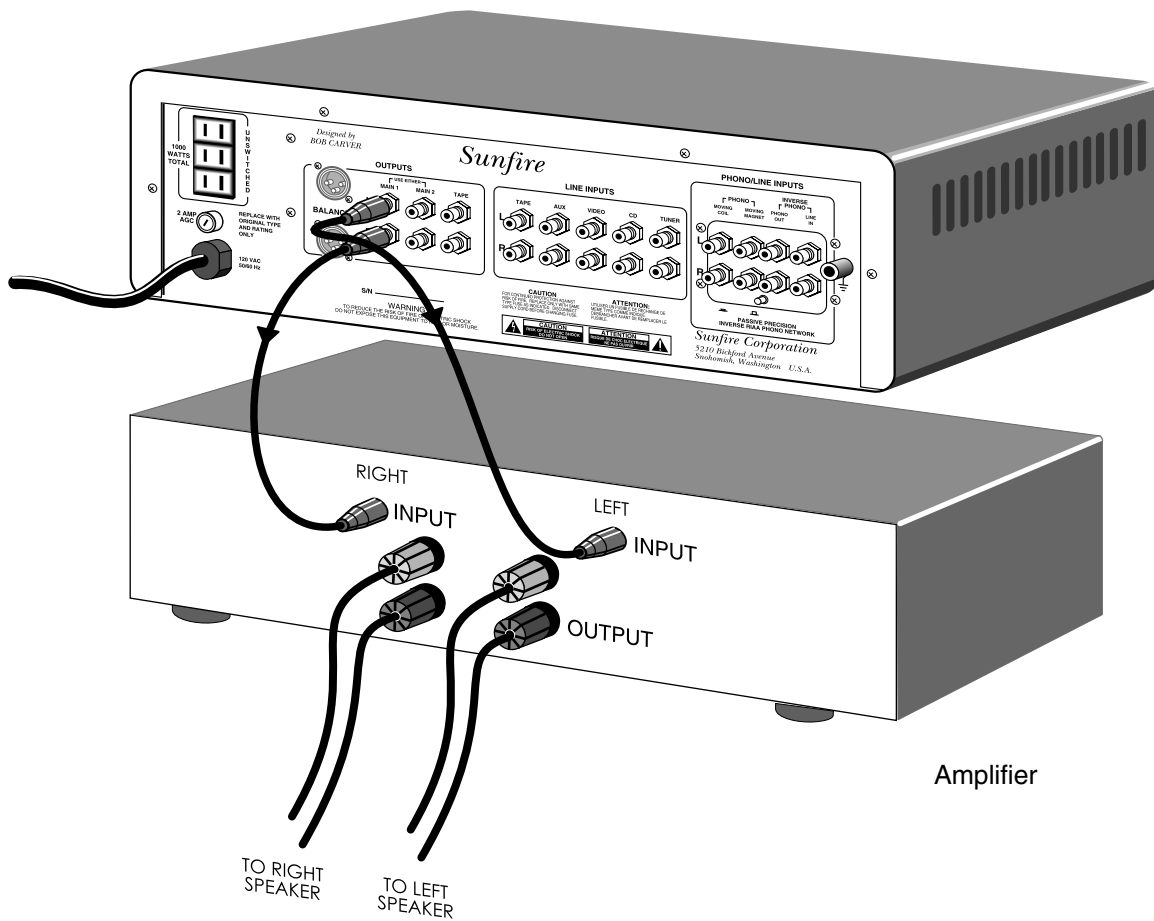

Amplifier

If your amplifier has RCA inputs, you can connect them to the preamplifier's Main 1 or Main 2 outputs. It does not matter which pair you use, because they are identical.

Main 2 is provided if you want to run a second amplifier, perhaps to play speakers in another room, or to drive an active subwoofer.

A third amplifier can be connected to the balanced XLR outputs if you have another set of speakers in a third room. Note that all the amplifiers would be playing the same music selection.

If you are using an electronic crossover to bi-amp or tri-amp your speakers:

- Connect a cable from either of the preamplifier's main outputs to the active crossover's inputs
- Connect the crossover's High, Mid, and Low outputs, as appropriate, to the separate power amplifiers in your system.

Amplifier Connections: unbalanced RCA

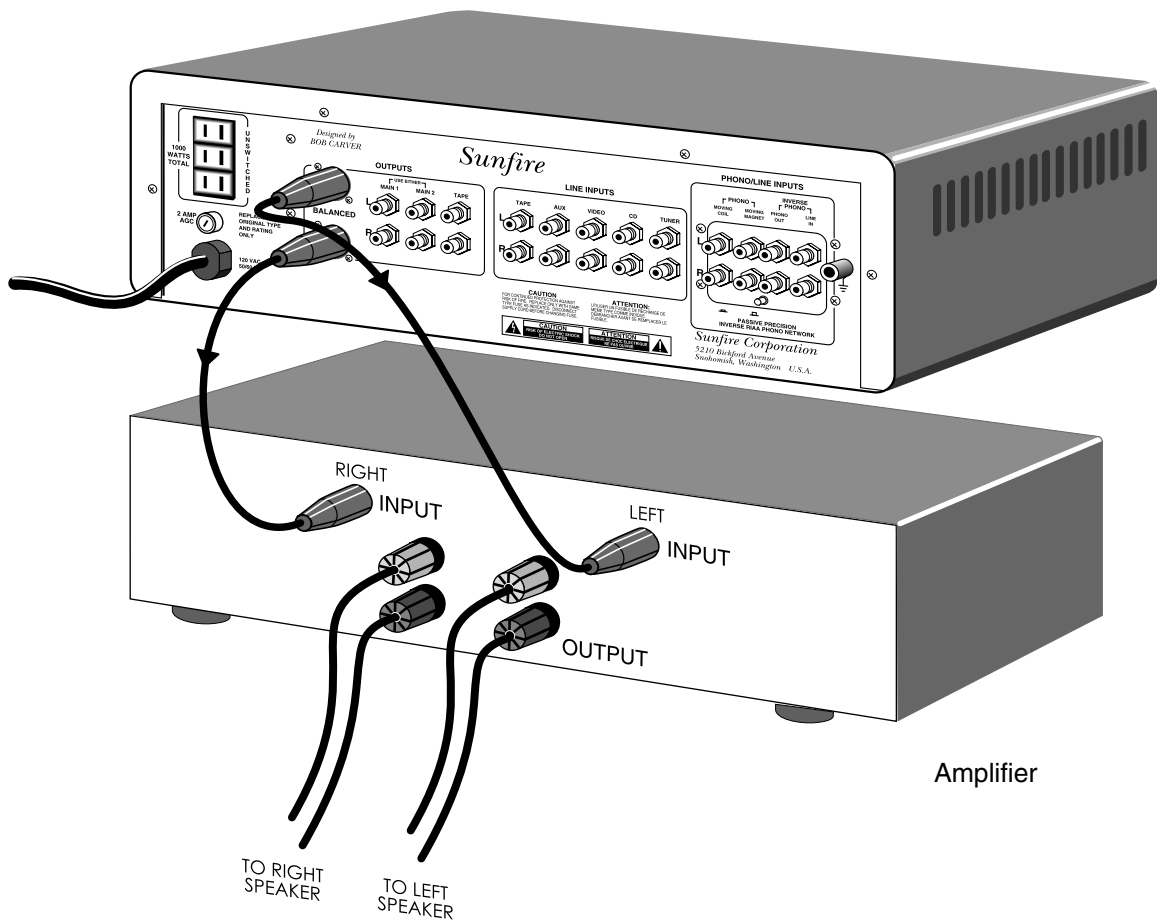

Amplifier

If your amplifier has XLR inputs, it can be connected to the balanced audio outputs as shown.

The balanced connections are preferred, as they provide superior noise cancellation and are less susceptible to interference than unbalanced lines.

Amplifier Connections: balanced XLR

Specifications

Phono Inputs

RIAA curve

Moving Magnet input

Gain = 40dB to tape out

Overload = 100mV @ 1 kHz.

Input Impedance = 47 Ω

Noise: better than 82 dB, IHF-A,
below 10mVrms at 1 kHz

Moving Coil input

Gain = 60dB to tape out

Overload = 5.60 mV @ 1 kHz.

Input Impedance = 470 Ω standard,
(setable to 22 Ω , 47 Ω , 150 Ω or 470 Ω)

Noise: better than 76 dB, IHF-A,
below 1000 μ Vrms at 1 kHz

High-Level Inputs

Frequency response

5 Hz to 50 kHz +0/-3dB

Line Gain = 12dB

Infrasonic Filter

18 dB per octave below 10 Hz

Noise

better than 96 dB, IHF-A, below 2 Vrms.

Distortion

THD: 0.5% or less, below 3 Vrms out.

IM (CCIR or SMPTE): 0.5% or less.

TIM unmeasurable.

Input Impedance nominally 50k Ω

Power Consumption

45 Watts with Phono option

25 Watts without Phono option

1.4 Watts remote standby (i.e. when it
has been turned off using the
remote control)

Finish

Black anodized front panel and cover

Dimensions

19" wide x 6.5" high x 18" deep.

Weight

25 pounds

Line Voltage

Units built for 110V-120V line voltage can be converted to 220V-240V by means of a modification. This is not simply a switch, and must be performed by a Sunfire Authorized Service Station. Contact Sunfire Technical Services for more information.

Muting System

The Sunfire Classic employs an electronic "clammer" to mute the main outputs to eliminate turn-on transients. (It will not interrupt the tape outputs).

Muting is accomplished by a shorting relay which, when it is "open", is out of the circuit and hence has no effect on the signal. It is controlled by a toggling device, so muting cannot be partially "on".

This muting system will turn off the signal to your power amplifier at these times:

- For about 40 seconds after the initial power-on, whether by the front panel power switch or the remote control.
- Immediately at turn-off, whether by the power switch or the remote control.
- The main outputs will also mute if the line voltage drops below 70 volts. This is to reduce thumping.

Output impedance

The output impedance of the Classic is a low 1.5K ohms, so it can drive power amplifiers having virtually any input impedance. Options include connecting several power amplifiers to the Classic's main outputs, to separately drive different speaker sets, or the use of extra-long connection cables to drive power amplifier(s) located close to the speakers, or self-powered loudspeakers. Conventional cables as long as 30 feet, or special low-capacitance cables as long as 60 feet, may be used to drive power amplifier(s) without difficulty.

©2001 Sunfire Corporation. All rights reserved. Sunfire Corporation reserves the right to improve its products at any time. Therefore, specifications are subject to change without notice.

Manual Part number : 913-012-00 Rev C

Troubleshooting

In view of the Classic's input/output flexibility, the many connecting cables to and from the components which may be connected to it, and the large number of possibilities for mis-set switches both on the Classic and on the various ancillary components operating with it, obviously it is impossible to offer a complete troubleshooting guide to all of the problems which could, in principle, occur. Most such potential problems will be avoided simply by following the instructions in this owner's manual and the instructions supplied with associated products; and many other possible problems will be prevented simply by the excellent reliability of modern components.

So in this section we will provide a guide to some of the most basic and common difficulties which may arise from time to time, and suggestions as to their probable causes. To illustrate the sort of thought process which is useful in tracking down problems, we begin with the most basic: no sound because the preamp's power is off. Did you accidentally hit the Power button when reaching for the Stereo/Mono button? Was the preamp's AC line cord accidentally pulled partially out of its wall socket during housecleaning earlier in the day? Did something else on that same household branch circuit (including the power amp or other component plugged in the preamp's AC convenience outlets) cause a current surge which blew the fuse or circuit breaker protecting that entire branch circuit? In some houses having duplex AC wall sockets, the lower one is permanently live while the upper one (intended for lamps) is controlled by a wall switch near a doorway; was the preamp's AC cord accidentally plugged into the switched socket? Is the preamp's AC cord plugged into a clock timer which is presently off or unplugged from the wall?

No sound.

- The preamplifier's power may be off, the amplifier off, line cords unplugged, AC fuses blown, or the power may be off at the wall socket or power strip.

No sound (the power is on)

- Input selector set to an inactive input.
- Tape monitor switch is engaged with no tape machine running.
- Input level controls are turned down on the power amplifier.
- Input or output signal cables may be disconnected.
- The selected program source is not operating.
- Output level control turned down at program source.
- Program source misadjusted (for example, the FM tuner is tuned between stations).

No sound (phono)

- Rear panel Phono MM/MC selector button in wrong position.
- Internal ribbon cable unplugged
- No phono power jumper in place on power supply board.

No sound in one channel.

- Defective cable from the preamp to the power amp or from a program source to the preamp.
- Speaker wire loose or disconnected.
- Balance control fully clockwise or counter-clockwise.
- Imperfect contact in a switch (especially any lever or slide switch in a program source or signal processor, as well as the various signal-routing switches in the preamp).
- A speaker's fuse is blown.

Loud howl, squeal, or whistle.

- The Tape Monitor switch is engaged while microphones (in the same room as the speakers) are connected to a tape deck for recording.
- Put the cat out.

Solo voices, or instruments sound thin, shrill or distorted.

- Phono cartridge is wired out of phase.

Hum

Under normal operating conditions you hear very little hum originating in the circuitry of the Classic. There is one exception to this rule: If you have a high-gain power amplifier and unusually sensitive (i.e. efficient) loudspeakers, normal listening levels will involve using abnormally low output levels from the preamp, and those small signals might then pick a bit of hum or hiss in the preamp's circuits. In this case the solution is to turn down the power amplifier's level controls if it has them, or consider having its gain reduced by the manufacturer. Contact Sunfire Technical Services for further information.

Except for the condition described above, audible hum will nearly always be found to be due to problems external to the Classic — usually in the signal source, i.e. the turntable or tape deck. Many turntables, for example, have a hum field in the vicinity of the platter due to the turntable's motor or internal power transformer which is acceptably low with moving-magnet cartridges but audibly bothersome with moving-coil cartridges. If your turntable has a non-polarized AC plug, you can experiment with reversing it to see which orientation of the plug minimizes the audible hum. The hum may also vary with the location and orientation of the turntable with respect to AC wiring in the walls, making it necessary to move the turntable to another part of the room.

Turntables and tape decks are sensitive to the external hum fields created by many power amplifiers, and sometimes to the hum fields of other house appliances (such as a refrigerator on the other side of the wall). It is important that signal cables in general, and the turntable signal leads in particular, should not run close to and parallel with AC power cords, nor close to a power transformer or motor (including that in the base of the turntable).

As a test, you might try and disconnect all cables which come from outside the room, such as cable TV, satellite TV, or roof top antennas. Make sure that they are disconnected where they first enter the room, so they are making no connection to your VCR, TV, or any other component. If you find that noise goes away when a cable TV line is disconnected, then you will need a "ground-loop isolator." This is an inexpensive device fitted in line with the coaxial cable feed.

If the hum persists, disconnect all the source components one at a time from the back of the preamplifier and you may identify the problem.

In many cases, hum may be eliminated by reversing the Classic's (unpolarized) AC power plug in the wall socket. In others it can be minimized by connecting a heavy stranded wire from the preamplifier's ground post to a true earth ground — which may turn out to be any, all, or none of the following: the third (round) hole in an electrical wall socket in modern U.S. homes, a steam radiator, or a cold water pipe. However, if your power amplifier employs a three-wire power cord, the stereo system may already be grounded through that, in which case another grounded wire from the preamp may create a "ground loop" and make the hum worse. As for the various components within the stereo system, they are mutually grounded via the shields of the signal cables and should not be interconnected with additional grounding wires, for the same reason (except, of course, the turntable; whose grounding wire usually (but not always) should be connected to the preamplifier's ground post).

Finally we come to the other common source of hum problems, the signal cables and their associated plugs. Inexpensive cables often have mediocre wrapped shielding, so better cables may make an audible difference. And it is important that the plug at each end of every cable makes a good, tight fit in its mating socket. (In this, don't neglect the "source" end of the turntable signal cables, which in many tables are plugged into sockets underneath rather than being soldered to terminals within the turntable's base). Crimp the leaves of the phono plug's skirt slightly inward, if necessary, to ensure that it has a tight friction-fit on the exterior of the phono jack. When plugging in each cable, use a rotary twisting motion as the plug goes into the jack, in order to scrape away any invisible surface corrosion and make a clean metal-to-metal contact. Finally, in many inexpensive molded cables, the wire breaks where it makes contact with the plug; this problem can be identified by wiggling the cable and listening for an intermittent signal connection or intermittent hum.

Radio Frequency Interference

Radio Frequency interference (RFI) from CB, TV, AM, and other radio transmitters is a common problem, and like hum it usually can be traced to a condition external to the Classic. Sometimes RFI gets into the power amp via the signal cables running from the preamp, and may be cured by substituting cables with better braided or foil shielding. More commonly RFI enters the power amp through its output terminals, with the speaker wires acting as receiving antennas. In this case it might be cured by connecting a 0.01 to 0.1 microfarad disc capacitor across the speaker terminals of each channel, but be sure to check with the amplifier manufacturer first; some power amps become unstable and burn out when certain values of capacitance are connected at their output terminals. A simple cure is to place the power amp near the speakers and use short wires; then use long well-shielded signal cables from the preamp to the power amp. This shouldn't cause any problems under normal conditions.

If the interference disappears when you mute the output of the preamp, then the interference is part of the signal and probably is entering the preamp from one or more of your signal sources. Use the Input Selector and Tape Monitor controls to identify which signal sources are picking up the interference, or unplug the sources one at a time. Usually turntables and tape decks are most vulnerable to RFI. If the RFI is coming in through the phono signal leads, cables with better shielding might help. Other options include wrapping the signal cables with aluminum foil which is then connected to the Ground post; or forming a loop in the cables, adjusting the size of the loop to tune out the interference, and taping it in place. And as with hum, try tightening all phono plugs and twist them in their sockets to get good metal-to-metal contact.

RFI in tape decks may enter via signal cables, but more commonly the interference is picked up directly in the playback head and its associated internal wiring, so a cure is likely to involve a trip to the factory or service shop for approved modifications. Or you might be able to reduce the interference to tolerable levels simply by turning the tape deck 90 degrees or moving it to another location in the room. A signal-processor, such as an equalizer, may be connected between either Main output set and the inputs of the power amplifier which drives the speakers you wish to equalize.

Appendix

Changing the phono stage gain

The following gain changes may be performed by experienced electronic technicians. Your Sunfire Dealer may be able to recommend a good service/repair shop.

Factory set gain of MM Phono is 40 dB. The gain may be changed as follows:

36 dB - change R 11 and R 35 to 3.9 K ohms

40 dB - R 11 and R 35 are 2.4 K ohms

44 dB - change R 11 and R 35 to 1.5 K ohms

These resistors are located on the circuit board close to the Phono stages. They are identified by white ink lettering. Changing these resistors will simultaneously increase the gain of the moving coil phono stage, i.e., by the same four dB increments.

Factory set gain of MC Phono is 60 dB. The gain may be changed independently of MM Phono as follows:

60 dB - Stock R4 and R28 are 62ohms, 1/2W

65 dB - change R4 and R28 to 33 ohms, 1/2W

70 dB - change R4 and R28 to 18 ohms, 1/2W

Changing the input impedance of the phono stage

Change the jumper position on the headers labeled J6 & J9 to the value recommended by your phono cartridge manufacturer. Most moving magnet cartridges work best at the 47k setting. Moving coil cartridges typically work best at a lower setting.

Tube type and location

Phono Board

V1	6DJ8 or 6922	MC amp
V2	6DJ8 or 6922	MC amp
V3	6DJ8 or 6922	MC amp
V4	12AX7	MM amp
V5	12AX7	MM amp
V6	6DJ8 or 6922	Infrasonic amp

Line Board

V1	6DJ8 or 6922	Contour amp
V2	6DJ8 or 6922	Line amp/Bal amp
V3	6DJ8 or 6922	Line amp/Bal amp

Note: 6922 Tubes are preferred as they have less noise and microphonics than 6DJ8s

Limited Warranty

Sunfire Corporation is proud of its products which have been built with care using advanced technology and premium component parts. Your unit has been crafted to perform properly for many years. Sunfire Corporation offers the following Warranty to you, the owner of a new Sunfire product:

The Sunfire Corporation Warranty for the Classic vacuum tube preamplifier is in effect for FIVE years from the date of original retail purchase. The Sunfire Corporation Warranty covers defects in materials and workmanship. The following, however, are excluded:

- a) Damage caused during shipment
- b) Damage caused by accident, misuse, abuse of operation contrary to the instructions specified in the Sunfire Corporation user's manual
- c) Units where the serial number has been defaced, modified or removed
- d) Damage resulting from modification or attempted repair by any person not authorized in writing by Sunfire Corporation.

The Sunfire Corporation Warranty extends to the original owner or subsequent owner(s) during the five year warranty period so long as the original dated purchase receipt is presented whenever warranty service is required.

All implied warranties, including warranties or merchantability and fitness for particular purposes, are limited in duration to the five year length of this Warranty, unless otherwise provided by state law.

Sunfire Corporation's liability is limited to the repair or replacement, at our option, of any defective product and shall not in any event include property or any other incidental or consequential damages which may result from the failure of this product.

Some states do not allow limitations on how long an implied warranty lasts and/or do not allow the exclusion or limitation of incidental or consequential damages, so the above limitations or exclusions may not apply to you.

This Warranty gives you specific legal rights, and you may also have other rights which vary from state to state. We suggest that you attach your purchase receipt to this Warranty and keep these in a safe place. Thank you for your choice of a Sunfire Corporation product.

Service Assistance

We suggest that you read the Limited Warranty completely to fully understand your Warranty/Service coverage.

If your Sunfire Corporation product ever requires service, write to us or call:

Sunfire Corporation
Technical Services Department
P.O. Box 1589
Snohomish, WA 98290
Tel (425) 335-4748
Fax (425) 335-4746

You will be directed to an authorized Sunfire Corporation Service Station or receive instructions to ship the unit to the factory. Please save the original shipping carton and packing materials in case shipping is required. Please do not ship Parcel Post.

NOTE: Before sending in your unit for repair, you must call Sunfire for return authorization.

Include a complete description of the problem, indicating how you have it connected, the associated equipment in your system and a copy of your purchase receipt. Initial shipping costs are not paid by Sunfire Corporation; return ground shipping costs will be prepaid if repairs were covered by the scope of this Warranty.

©2001, Sunfire Corporation. All rights reserved.

Bob Carver's *Sunfire*

...from his mind & soul

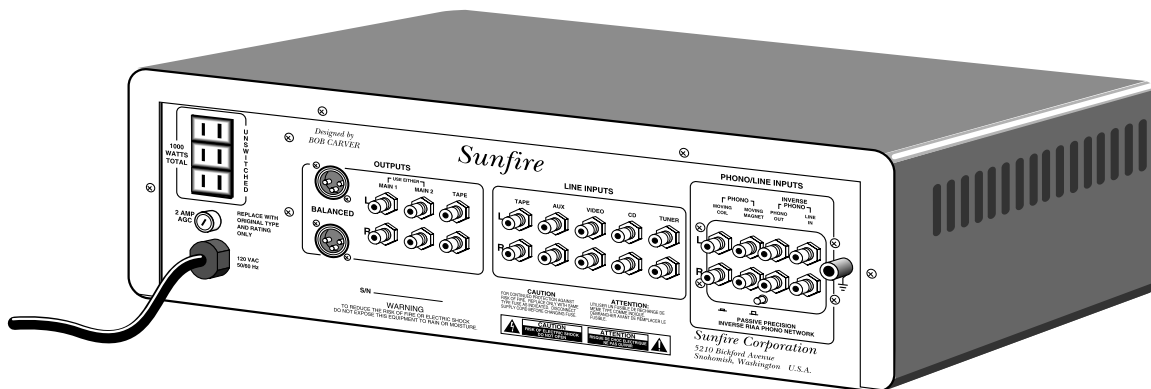

Classic Vacuum Tube Preamplifier

*Sunfire Corporation
P.O. Box 1589
Snohomish
WA 98291*
